

**Bussmann series open and enclosed  
rotary disconnect switches**

**BUSSMANN**  
SERIES

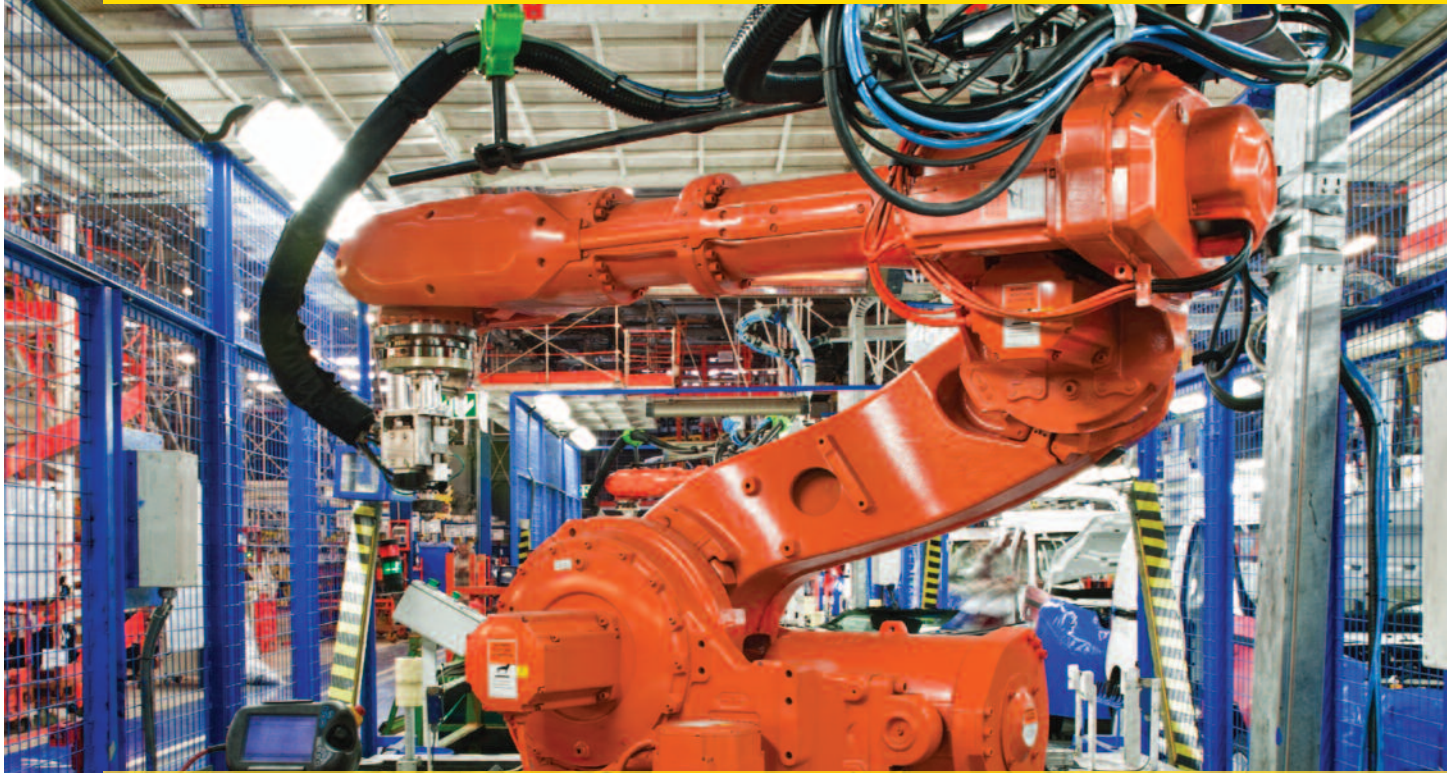

Exceptional breadth and availability for your application



**EATON**

*Powering Business Worldwide*



# Eaton and Cooper united. Energizing a world that demands more.

## We deliver:

- **Electrical solutions** that use less energy, improve power reliability and make the places we live and work safer and more comfortable
- **Hydraulic and electrical solutions** that enable machines to deliver more productivity without wasting power
- **Aerospace solutions** that make aircraft lighter, safer and less costly to operate, and help airports operate more efficiently
- **Vehicle drivetrain and powertrain solutions** that deliver more power to cars, trucks and buses, while reducing fuel consumption and emissions

Discover today's Eaton.

## Powering business worldwide

As a global diversified power management company, we help customers worldwide manage the power needed for buildings, aircraft, trucks, cars, machinery and businesses.

Eaton's innovative technologies help customers manage electrical, hydraulic and mechanical power more reliably, efficiently, safely and sustainably.

We provide integrated solutions that help make energy, in all its forms, more practical and accessible.

With 2012 sales of \$16.3 billion, Eaton has approximately 103,000 employees around the world and sells products in more than 175 countries.

[Eaton.com](http://Eaton.com)



## Table of contents

### Compact Circuit Protector (CCP) disconnect switches

30A Class CC, Midget & 10x38	4-5
30A 60A and 100A Class CF	6-7



### UL 98 fused disconnect switches 30 to 800A

Introduction and Agency Information	8
Product Line Summary	9
30A Compact Class CC & Class J	10-11
30A Class J	12-13
60A Compact Class J	14-15
60A Class J	16-17
100A Class J	18-19
200A & 400A Class J	20-22
600A Class J and 800A Class L	24-25



### UL 98 non-fused disconnect switches 30 to 1200A

Introduction and Agency Information	26
Product Line Summary	27
30A, 60A and 100A Compact	28-29
100A, 200A and 400A Standard	30-31
600A, 800A, 1000A and 1200A Standard	32-33



### UL 508 non-fused disconnect switches 16 to 80A

Introduction and Agency Information	34
Product Line Summary	35
16A, 25A, 40A, 63A and 80A Standard	36-38



### Enclosed UL 98 and UL 508 disconnect switches

Introduction and Agency Information	39
<b>Fused UL 98</b>	
30A to 800A Enclosed Disconnects	40-41
<b>Non-Fused UL 98</b>	
30 to 1200A Enclosed Disconnects	42-43
<b>Non-Fused UL 508</b>	
16 to 80A Enclosed Disconnects	44-45



### Catalog number index 46-47

Bussmann circuit protection solutions comply with major industrial standards and agency requirements such as: BS, IEC, DIN, UL, NEMA, SAE, CSA, CE, C-UL, etc. and are manufactured at facilities that are ISO 9000 certified. This catalog is intended to present product data and provide technical information that will help the end user with design application. Bussmann reserves the right, without notice, to change design or construction of any products and to discontinue or limit distribution of any products. Bussmann also reserves the right to change or update, without notice, any technical information contained in this catalog. Once a product has been selected, it should be tested by the user in all possible applications. Further, Bussmann takes no responsibility for errors or omissions contained in this catalog, or for misapplication of any Bussmann product. Extensive product information is available in the Bussmann product data sheets available online at [www.cooperbussmann.com](http://www.cooperbussmann.com).

# Compact Circuit Protector (CCP) Disconnect Switch — 30A

1-, 2- & 3-Pole, Class CC, UL Midget & 10x38mm IEC



Amp Rating	UL Fuse Class	No. of Poles	Volts	SCCR	Max Horsepower Rating*				Wire Size/ (Torque†††)	Wire Type	Part Number	Agency Information
					120 Vac	240 Vac	480 Vac	600 Vac				
30	CC	1	600Vac	200kA	0.5	—	—	—	Single/Dual 8-6AWG Sol/Str	75°C Cu or higher	CCP-1-30CC	UL 98 Listed, cULus 22.2, No. 4-04
30	CC	2	600Vac	200kA	—	2	—	—			CCP-2-30CC	UL 98 Listed, cULus 22.2, No. 4-04
30	CC	3	600Vac	200kA	—	3	4	7.5			CCP-3-30CC	UL 98 Listed, cULus 22.2, No. 4-04
30	UL Midget	1	240Vac†	10kA†	—	—	—	—	Single 4AWG Sol/Str	75°C Cu or higher	CCP-1-30M	UL 508 Listed, cULus 22.2, No. 14-05
32*	10x38 IEC		400Vac†	120kA†	—	—	—	—				UL 508 Listed, cULus 22.2, No. 14-05
30	UL Midget	2	240Vac†	10kA†	—	—	—	—	Single 4AWG Sol/Str	75°C Cu or higher	CCP-2-30M	UL 508 Listed, cULus 22.2, No. 14-05
32*	10x38 IEC		400Vac†	120kA†	—	—	—	—				IEC 60947-3, AC-23A
30	UL Midget	3	240Vac†	10kA†	—	—	—	—	Single 4AWG Sol/Str	75°C Cu or higher	CCP-3-30M	UL 508 Listed, cULus 22.2, No. 14-05
32*	10x38 IEC		400Vac†	120kA†	—	—	—	—				IEC 60947-3, AC-23A
30	CC	1	80Vdc†	20kA†	—	—	—	—	Fork Terminal††	—	CCP-1-DCC	UL 98 Listed, CSA 22.2, No. 4-04
30	UL Midget	1	80Vdc†	10kA†	—	—	—	—	Fork Terminal††	75°C Cu or higher	CCP-1-DCM	UL 508 Listed, cULus 22.2, No. 14-05
32*	10x38 IEC		400Vac†	120kA†	—	—	—	—				IEC 60947-3, DC-23A

\*32A Class aM, 25A Class gG.

†SCCR May be lower, refer to installed fuse data sheets.

††Fork terminal with a 4.3mm gap for a #8-32 stud, 30A max, insulated flange, wire size 12-10AWG.

†††- 18-10AWG; 20 Lb-In

- 8-4AWG; 35 Lb-In

## Specifications

### Agency Information

- CE Compliant
- RoHS Compliant
- For Class CC fuse versions
  - UL 98 Listed, File E302370, Guide WHTY
  - cULus to CSA Standard 22.2 No. 4-04, File 302370, Guide WHTY7
- For UL Midget and 10X38 IEC fuse versions
  - UL 508 Listed, File E320230, Guide NRNT
  - cULus Certified 22.2 No. 14-05
  - IEC 60947-3 AC23A
  - IEC 60947-3 DC23A

### Terminals

- Single/dual conductor box lug or spade terminal suitable for line, load or accessory connection

### Torque

- 18-10AWG 20 Lb-In
- 8-4AWG 35 Lb-In

### Storage and Operating Temperature

- -20°C to 75°C\*

\* For fuse performance under or above 25°C, consult fuse performance derating charts in the Bussmann publication titled *Selecting Protective Devices (SPD)*, reorder #3002.

### Flammability Rating

- UL 94V0

### Lockout/Tagout Provisions

- 4mm shank lock or Brady pin-out device, part number 90850

### Mounting

- 35mm DIN-Rail

### Local Open Fuse Indication Minimum Voltage\*\*

- 90Vac for AC versions
- 12Vdc for DC versions

\*\* Open fuse indication requires an open fuse to be in the CCP and the switch in the ON position.

## Features

- IP20 Finger-safe construction with #10 or larger wire
- Switch interlock prohibits removing the fuse under load

## Accessories

- Auxiliary contacts
- PLC Wired remote fuse indication

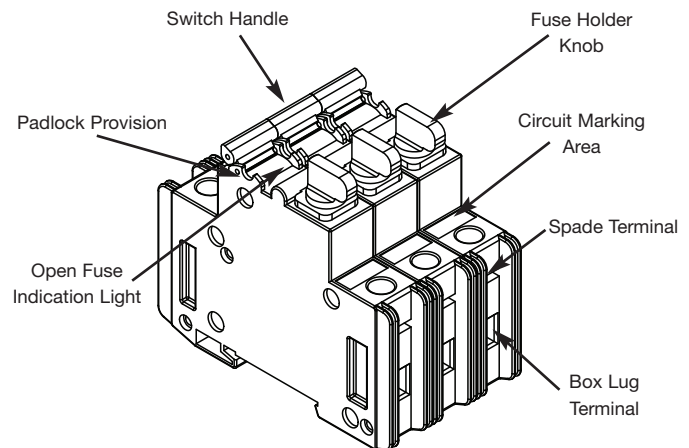

## Available Bussmann Fuses

Fuse Class	Type/Description	Volts	Data Sheet #
CC	LP-CC Time-Delay, Current Limiting	600Vac/300Vdc	1023
CC	FNQ-R Time-Delay	600Vac/300Vdc	1014
CC	KTK-R Fast-Acting	600Vac	1015
M	FNM Time-Delay	250Vac	2028
M	FNQ Time-Delay	500Vac	1012
M	KTK Fast-Acting	600Vac	1011
M	BAF Fast-Acting	250Vac	2011
M	KLM Fast-Acting	600Vac/dc	2020
gG/gL	C10G	500V (400V@32A)	720115
aM	C10M	500V (400V@20@25A)	720115

Data Sheet: 1157

# Compact Circuit Protector (CCP) Disconnect Switch—30A

1-, 2- & 3-Pole, Class CC, UL Midget & 10x38mm IEC

**Dimensions – mm (in)**

Class CC, UL Midget & 10x38 IEC

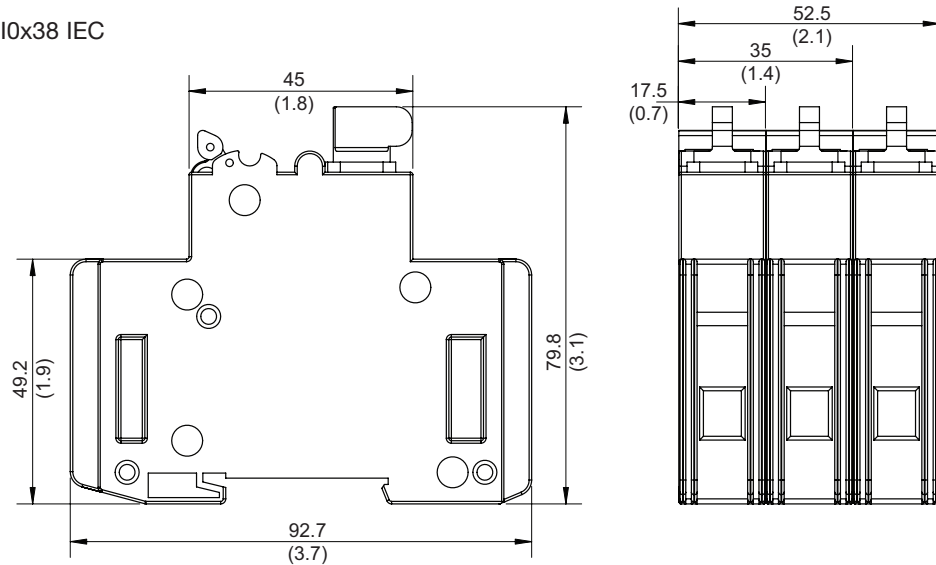

Auxiliary Contacts



PLC Indicator  
(Includes leads with spade terminals)

CCP-_-30_Accessories					
Description	Max Per CCP	Signal Output	Minimum Circuit Voltage	Agency Information	Part Number
Auxiliary Contacts NO+NC for Switch Status	1 per CCP (1-, 2- or 3-pole)	5A/ 240Vac	—	UL 98 Recognized, cURus 22.2 No. 4-04, IEC 60947-5-1 AC-15	CCP-AUX*
PLC Fuse Monitor for Open Fuse Indication	1 per CCP (1-, 2- or 3-pole)	24Vdc/ 10mA	100Vac	UL 98 Recognized, cURus 22.2 No. 4-04	CCP-PLC-IND*

\* Refer to Data Sheet # 1157 for details.

# Compact Circuit Protector (CCP) Disconnect Switch—30, 60 & 100A

1-, 2- & 3-Pole, Class CF CUBEFuse™



Amp Rating	UL Fuse Class	No. of Poles	Volts	SCCR	Max Horsepower Rating*				Wire Size (See Note for Torquet)	Wire Type	Part Number	Agency Information
					120 Vac	240 Vac	480 Vac	600 Vac				
30	CF	1	600Vac	200kA	1.5	—	—	—	Single/Dual 18-6AWG Sol/Str	75°C Cu or higher	CCP-1-30CF	UL 98 Listed, cULus 22.2, No. 4-04
			125Vdc	100kA							CCP-2-30CF	
30	CF	2	600Vac	200kA	—	3	—	—	Single 4AWG Sol/Str	75°C Cu or higher	CCP-3-30CF	UL 98 Listed, cULus 22.2, No. 4-04
			125Vdc	100kA							CCP-1-60CF	
30	CF	3	600Vac	200kA	—	5	15	10	Spade Terminal**	75°C Cu or higher	CCP-2-60CF	UL 98 Listed, cULus 22.2, No. 4-04
			125Vdc	100kA							CCP-3-60CF	
60	CF	1	600Vac	200kA	3	—	—	—	Single 8-10AWG Sol/Str	75°C Cu or higher	CCP-1-100CF	UL 98 Listed, cULus 22.2, No. 4-04
			125Vdc††	100kA							CCP-2-100CF	
60	CF	2	600Vac	200kA	—	7.5	—	—	8-1AWG Str Dual	75°C Cu or higher	CCP-3-100CF	UL 98 Listed, cULus 22.2, No. 4-04
			125Vdc††	100kA							CCP-2-100CF	
60	CF	3	600Vac	200kA	—	7.5	20	15	6AWG Str Spade Terminal**	75°C Cu or higher	CCP-3-100CF	UL 98 Listed, cULus 22.2, No. 4-04
			125Vdc††	100kA							CCP-3-100CF	
100	CF	1	600Vac	200kA	5	—	—	—	Single 8-10AWG Sol/Str	75°C Cu or higher	CCP-1-100CF	UL 98 Listed, cULus 22.2, No. 4-04
			125Vdc†††	100kA							CCP-2-100CF	
100	CF	2	600Vac	200kA	—	10	—	—	8-1AWG Str Dual	75°C Cu or higher	CCP-3-100CF	UL 98 Listed, cULus 22.2, No. 4-04
			125Vdc†††	100kA							CCP-2-100CF	
100	CF	3	600Vac	200kA	—	20	50	40	6AWG Str Spade Terminal**	75°C Cu or higher	CCP-3-100CF	UL 98 Listed, cULus 22.2, No. 4-04
			125Vdc†††	100kA							CCP-3-100CF	

\* With time-delay Low-Peak CUBEFuse.  
 \*\* Spade terminal with a 4.3mm gap for a #8-32 stud, 30A max, insulated flange, wire size 12-10AWG.  
 † 30-60A: 18-10AWG 20 Lb-In, 8-6AWG 35 Lb-In, 4AWG 35 Lb-In. 70-100A: 18-10AWG Single 25 Lb-In, 8-1AWG Single 35 Lb-In, 6AWG Dual 45 Lb-In.  
 †† Up to 40A max.  
 ††† Up to 80A max.

## Specifications

### Agency Information

- CE Compliant
- RoHS Compliant
- UL 98 Listed, File E302370, Guide WHTY
- cULus to CSA Standard 22.2 No. 4-04, File 302370, Guide WHTY7

### Terminals

- Single/dual conductor box lug or spade terminal suitable for line, load or accessory connection
- Torque: 0-60A:
  - 18-10AWG 20 Lb-In
  - 8-6AWG 35 Lb-In
  - 4AWG 35 Lb-In
- 70-100A:
  - 18-10AWG Single 25 Lb-In
  - 8-1AWG Single 35 Lb-In
  - 6AWG Dual 45 Lb-In

### Fuses

- Uses finger-safe Class CF CUBEFuse™ with Class J performance
- Low-Peak™ dual-element, time-delay\*
  - Non-indicating 1-100A
  - Indicating 6-100A
- Fast-acting, non-indicating 1-100A\*\*

\* See Data Sheet # 9000  
 \*\* See Data sheet # 2147

### Storage and Operating Temperature

- -20°C to 75°C\*\*\*

\*\*\* For fuse performance under or above 25°C, consult fuse performance derating charts in the Bussmann publication titled *Selecting Protective Devices (SPD)* reorder #3002.

### Flammability Rating

- UL 94V0

### Lockout/Tagout Provisions

- 4mm shank lock or Brady pin-out device, part number 90850

Data Sheet: 1157

## Mounting

- 35mm DIN-Rail

## Local open fuse indication minimum voltage†

- 90V

† Open fuse indication requires an open fuse to be in the CCP and the switch in the ON position.

## Features

- Ampacity rejecting disconnects will not accept CUBEFuse amp ratings greater than switch rating
- IP20 Finger-safe construction with 10AWG (6mm<sup>2</sup>) wire or larger
- Built-in switch interlock capability prohibits removing the fuse under load

## Accessories

- Auxiliary contacts
- PLC Wired remote fuse indication
- CUBEFuse pullers (P/Ns: CFP-30, CFP-60, CFP-100)

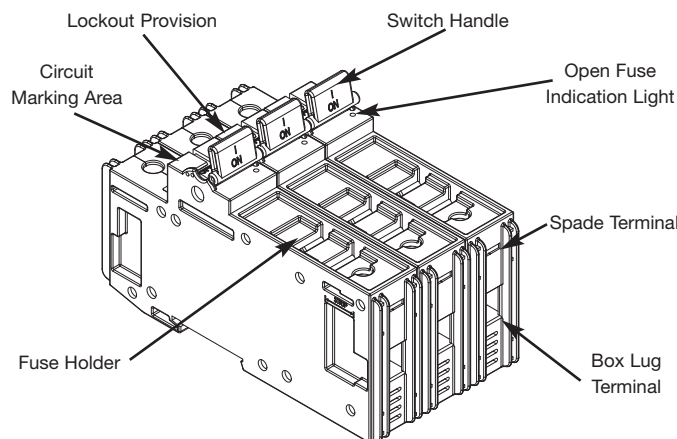

# Compact Circuit Protector (CCP) Disconnect Switch—30, 60 & 100A 1-, 2- & 3-Pole, Class CF CUBEFuse™

Dimensions – mm (in)  
30 and 60 Amp

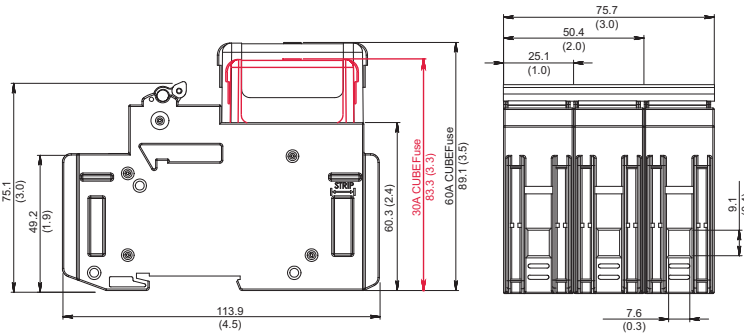

100 Amp

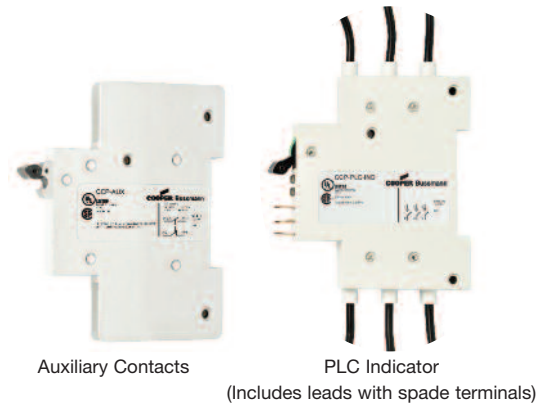
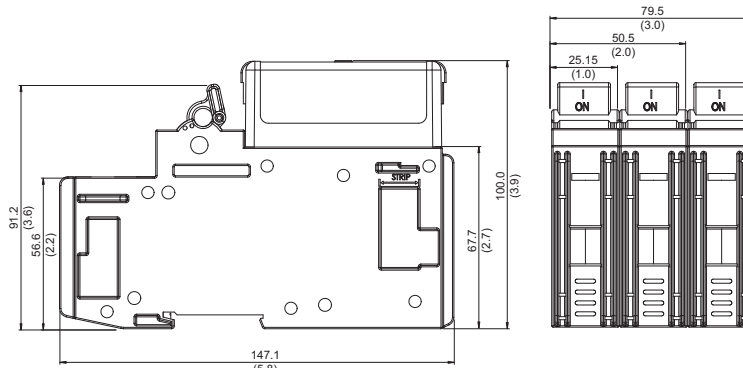

CCP- _ _ CF Accessories					
Description	Max Per CCP	Signal Output	Minimum Circuit Voltage	Agency Information	Part Number
Auxiliary Contacts NO+NC for Switch Status up to 60A	1 per CCP (1-, 2-, 3-Pole)	5A/ 240Vac	-	UL 98 Recognized, cURus 22.2 No. 4-04, IEC 60947-5-1 AC15	CCP-AUX*
Auxiliary Contacts NO+NC for Switch Status 70 to 100A	1 per CCP (1-, 2-, 3-Pole)	5A/ 240Vac	-	UL 98 Recognized, CSA C22.2 No. 4	CCP-AUX-100*
PLC Fuse Monitor for Open Fuse Indication 70 to 100A	1 per CCP (1-, 2-, 3-Pole)	24Vdc/ 10mA	100Vac	UL 98 Recognized, cURus 22.2 No. 4-04	CCP-PLC-IND*
PLC Fuse Monitor for Open Fuse Indication 70 to 100A	1 per CCP (1-, 2-, 3-Pole)	24Vdc/ 10mA	100Vac	UL 98 Recognized, CSA C22.2 No. 4	CCP-PLC-100*

\* Refer to Data Sheet # 1157 for details.

# UL 98 Fused Rotary Disconnect Switches—30 to 800A

## Description

Bussmann UL 98 and UL 489 fused disconnect switches “break” and “make” power circuits ON and OFF load.

The switches employ double break contacts per pole that help ensure complete isolation of the fuse when the switch is in the “OFF” position.

## Features

- Make and break power under load
- Double break by pole
- DIN-Rail or panel mount (30-100A)
- Up to 200kA Short-Circuit Current Rating
- Finger-safe covers
- Compact footprints available
- Defeatable handles automatically re-latch when the panel door is closed
- Most disconnect switches are front, right side, flange or direct handle operable
- NFPA 79 Compliant handle kits

## Agency Information

- UL 98, Guide WHTY, File E155130
- UL 489, Guide WJAZ, File E359801
- CSA 22.2 No. 4, File 257020
- Conforms with IEC 60947-3
- NFPA 79 (2002 Edition)

## Online Resources

Visit [www.cooperbussmann.com/Disconnects](http://www.cooperbussmann.com/Disconnects) for:

- CAD Drawings
- Instruction Sheets
- UL Information

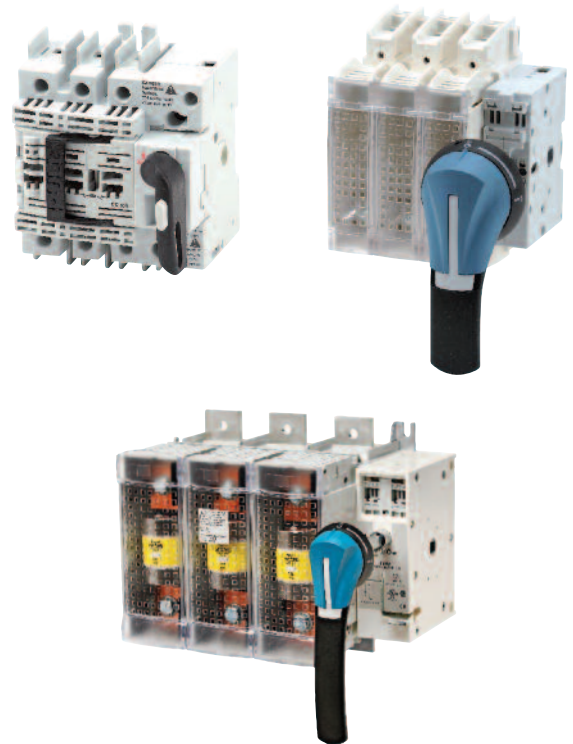





QuikShip Everyday Service ships the most common part numbers within 24 hours. Contact your Bussmann representative for details.

Available Bussmann Fuses		
Class	Type	Data Sheet #
CC	LP-CC Time-Delay, Current Limiting	1023
CC	FNQ-R Time-Delay	1014
CC	KTK-R Fast-Acting	1015
J	LPJ Time-Delay, Current Limiting	1006 (0-60A)
J		1007 (70-600A)
J	JKS Fast-Acting Fuses	1026 (0-60A)
J		1027 (70-600A)
J	DFJ High Speed Drive Fuse	1048 (0-600A)
L	KRP-C Time-Delay, Current Limiting	1008
L	KTU Fast-Acting	1010
L	KLU Time-Delay	1013

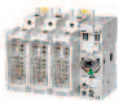

# UL 98 Fused Rotary Disconnect Switches—30 to 800A

UL Electrical Specifications										
	RDF30CC-3		RDF30J-3 / RDF60J-3-COMP		RDF60J-3		RDF200J-3		RDF600J-3	
<b>Part Number</b>	—		RDF30J-2	RDF60J-2-COMP	RDF60J-2	RDF100J-2	RDF200J-2	RDF400J-2	RDF600J-2	RDF800L-2
<b>2-Pole</b>	—		RDF30J-3	RDF60J-3-COMP	RDF60J-3	RDF100J-3	RDF200J-3	RDF400J-3	RDF600J-3	RDF800L-3
<b>3-Pole</b>	RDF30CC-3	RDF30J-3-COMP	—	—	—	—	—	—	—	—
<b>3-Pole + Neutral</b>	RDF30CC-3N	RDF30J-3N-COMP	—	—	—	—	—	—	—	—
<b>4-Pole</b>	—		RDF30J-4	RDF60J-4-COMP	RDF60J-4	RDF100J-4	RDF200J-4	RDF400J-4	RDF600J-4	RDF800L-4
UL Standard	UL 489	UL 489	UL 98	UL 98	UL 98	UL 98	UL 98	UL 98	UL 98	UL 98
Fuse Class	CC	J	J	J	J	J	J	J	J	L
Max Fuse/Ampacity	30	30	30	60	60	100	200	400	600	800
Switch Type	Compact	Compact	Standard	Compact	Standard	Standard	Standard	Standard	Standard	Standard
Handle Operation	Front	Front	Front/Side Flange	Front/Side Flange	Front/Side Flange	Front/Side Flange	Front/Side Flange	Front/Side	Front	Front
<b>UL Electrical Ratings</b>										
Max AC Volts	600Vac	600Vac	600Vac	600Vac	600Vac	600Vac	600Vac	600Vac	600Vac	600Vac
Max DC Volts*	—	—	250Vdc	250Vdc	250Vdc	250Vdc	—	250Vdc	600Vdc	600Vdc
Std AC Horsepower Ratings										
1-Phase, 240Vac	—	—	3	10	10	10	10	10	—	—
3-Phase, 240Vac	3	3	3	7.5	7.5	15	25	50	75	75
3-Phase, 480Vac	5.0	5.0	5.0	15	15	25	50	100	150	200
3-Phase, 600Vac	7.5	7.5	7.5	15	15	30	60	125	200	250
Max AC Horsepower Ratings										
3-Phase, 240Vac	7.5	7.5	7.5	15	15	30	60	125	200	200
3-Phase, 480Vac	15	15	15	30	30	60	125	250	400	500
3-Phase, 600Vac	20	20	20	50	50	75	150	350	500	500
DC Horsepower Ratings										
125Vdc	—	—	3	5	5	7.5	—	20	—	—
250Vdc	—	—	5	10	10	20	—	50	—	—
<b>Electrical Characteristics</b>										
SCCR	100kA	100kA	200kA	100kA	200kA	200kA	200kA	200kA	200kA	200kA
Terminal Lugs/Kits	Integral	Integral	Integral	Integral	Integral	Integral	•	•	•	•
Mounting Torque - Lb-In (N•m)	—	—	—	—	—	—	160 (18)	310 (35)	310 (35)	310 (35)
Wire Type	75°C Cu	75°C Cu	75°C Cu	75°C Cu	75°C Cu	75°C Cu	75°C Cu/Al	75°C Cu/Al	75°C Cu/Al	75°C Cu/Al
Wire Range & Torque - Lb-In (N•m)										
Solid	#14-10	#14-10	#14-10	#14-10	#12-10	#12-10	—	—	—	—
Stranded	27 (3.1) #14-10	27 (3.1) #14-10	31 (3.5) #14-6 31 (3.5)	31 (3.5) #14-6 31 (3.5)	35.4 (4) #12-1 35.4 (4)	35.4 (4) #12-1 35.4 (4)	#6-300MCM 275 (31)	#4-600MCM 550 (62) Dual 1/0-250MCM 550 (62)	(2) #2-600MCM 375 (42.4)	(2) #2-600MCM 375 (42.4)
<b>Mechanical Characteristics</b>										
Endurances/Cycles	10,000	10,000	10,000	10,000	10,000	10,000	8000	6000	5000	5000
<b>Physical Characteristics</b>										
Dimensions	See drawings on product pages									
Weight - Lbs (KG)										
2-Pole	—	—	3.0 (1.3)	3.1 (1.4)	4.0 (1.8)	4.07 (1.8)	5.7 (2.6)	11.4 (5.2)	31.7 (14.4)	31.7 (14.4)
3-Pole	1.3 (0.6)	1.4 (0.6)	3.8 (1.7)	4.1 (1.8)	5.3 (2.4)	5.3 (2.4)	7.8 (3.5)	16.6 (7.6)	44.2 (20.1)	44.2 (20.1)
3-Pole + Neutral	1.4 (0.6)	1.5 (0.7)	—	—	—	—	—	—	—	—
4-Pole	—	—	4.7 (2.1)	4.8 (2.2)	X.X (2.9)	6.49 (2.9)	10.8 (4.9)	21.8 (9.9)	56.8 (25.8)	56.8 (25.8)
<b>Environmental</b>										
Operating Temp. Range	-20°C to 70°C	-20°C to 70°C	-20°C to 70°C	-20°C to 70°C	-20°C to 70°C	-20°C to 70°C	-20°C to 70°C	-20°C to 70°C	-20°C to 70°C	-20°C to 70°C
Flammability Rating	UL 94-V0	UL 94-V0	UL 94-V0	UL 94-V0	UL 94-V0	UL 94-V0	UL 94-V0	UL 94-V0	UL 94-V0	UL 94-V0
<b>Accessories</b>										
Lug Kit	Integral	Integral	Integral	Integral	Integral	Integral	•	•	•	•
Handles										
Direct	•	•	•	•	•	•	•	•	•	•
Front Selector	•	•	—	—	—	—	—	—	—	—
Front Pistol	•	•	•	•	•	•	•	•	•	•
Side Pistol	—	—	•	•	•	•	•	•	•	—
Flange										
Cable	—	—	•	•	•	•	•	•	•	—
Shaft	—	—	•	•	•	•	•	•	•	—
NFPA Through Door Handle	•	•	•	•	•	•	•	•	•	•
Shafts c/s - mm	5x5	5x5	10x10	10x10	10x10	10x10	10x10	10x10	12X12	12X12
Terminal Shrouds	Not Required	Not Required	Not Required	Not Required	Not Required	Not Required	•	•	•	•
Auxiliary Contacts										
(1) NO	•	•	•	•	•	•	•	•	•	•
(1) NC	•	•	•	•	•	•	•	•	•	•
AC Ratings										
Volts	600	600	600	600	600	600	600	600	600	600
Amps	10	10	10	10	10	10	10	10	10	10

• Available, see product page for details and part numbers.  
 — Not available.  
 \* General purpose only, not photovoltaic rated.

# UL 98 Fused Rotary Disconnect Switches—30A

Compact Class CC & Class J

For a Complete Assembly, Please Select:

SWITCH		<b>Switch</b>										
		<b>Amp Rating</b>	<b>Fuse Class</b>	<b>Number of Poles</b>	<b>SCCR</b>	<b>Max Horsepower Rating, 3-Ph</b>			<b>Wire Size</b>	<b>Wire Type</b>	<b>Part Number</b>	
		30	CC	3	100kA	7.5	15	20	#14-10 Sol/Str	75°C Cu	RDF30CC-3	
		30	CC	3 + Ntrl*	100kA	7.5	15	20	#14-10 Sol/Str	75°C Cu	RDF30CC-3N	
		30	J	3	100kA	7.5	15	20	#14-10 Sol/Str	75°C Cu	RDF30J-3-COMP	
		30	J	3 + Ntrl*	100kA	7.5	15	20	#14-10 Sol/Str	75°C Cu	RDF30J-3N-COMP	
		* Neutral is switched.										
+												
HANDLE		<b>Direct Mount Handle - mounts directly to switch, no shaft required</b>										
		<b>For Switch Part Number</b>	<b>Color</b>	<b>Test Function</b>	<b>Padlockable</b>	<b>Defeatable</b>	<b>Part Number</b>					
		RDF30CC- RDF30J-_-COMP	Black Black	Y Y	Y Y		DIR-05 DIR-06					
OR												
SELECT FOR STANDARD APPLICATIONS		<b>External Front Operated Selector Handle - shaft required</b>										
		<b>NEMA Type</b>	<b>Color</b>	<b>Test Function</b>	<b>Padlockable</b>	<b>Defeatable</b>	<b>Part Number</b>					
		1, 3R, 4, 4X, 12	Black	N	Y	Y	H4X-04B					
		1, 3R, 4, 4X, 12	Red/Yellow	N	Y	Y	H4X-04R					
		<b>Shafts for Selector Handles</b>										
		<b>Length in (mm)</b>	<b>Mounting Depth (X) in (mm)</b>	<b>Part Number</b>								
		7.9 (200)	4.02~9.65 (102~245)	SH1-200								
		12.6 (320)	4.02~14.37 (102~365)	SH1-320								
		15.7 (400)	4.02~17.52 (102~445)	SH1-400								
OR												
HANDLE		<b>External Front Operated Pistol Handles - shaft required</b>										
		<b>NEMA Type</b>	<b>Color</b>	<b>Test Function</b>	<b>Padlockable</b>	<b>Defeatable</b>	<b>Part Number</b>					
		1, 3R, 12	Black	N	Y	Y	H12-05B					
		1, 3R, 12	Red/Yellow	N	Y	Y	H12-05R					
		1, 3R, 4, 4X, 12	Black	N	Y	Y	H4X-05B					
		1, 3R, 4, 4X, 12	Red/Yellow	N	Y	Y	H4X-05R					
		1, 3R, 4, 4X, 12	Black	Y	Y	Y	H4X-05TB					
		1, 3R, 4, 4X, 12	Red/Yellow	Y	Y	Y	H4X-05TR					
		<b>Metallic Hasp (Heavy Duty) External Front Operated Pistol Handles - shaft required</b>										
		<b>NEMA Type</b>	<b>Color</b>	<b>Test Function</b>	<b>Padlockable</b>	<b>Defeatable</b>	<b>Part Number</b>					
		1, 3R, 4, 4X, 12	Black	N	Y	Y	H4X-05BHD					
		1, 3R, 4, 4X, 12	Red/Yellow	N	Y	Y	H4X-05RHD					
		<b>Shafts for Pistol Handles</b>										
		<b>Length in (mm)</b>	<b>Mounting Depth (X) in (mm)</b>	<b>Part Number</b>								
		7.9 (200)	4.02~9.65 (102~245)	SH2-200								
		12.6 (320)	4.02~14.37 (102~365)	SH2-320								
		15.7 (400)	4.02~17.52 (102~445)	SH2-400								
OR												
ACCESSORIES		<b>NFPA Through the Door Handle Kit - to be used with front pistol handle</b>										
		<b>Color</b>	<b>Test Function</b>	<b>Padlockable</b>	<b>Defeatable</b>	<b>Part Number</b>						
		Red	N	Y	N	H79-1						
and...												
ACCESSORIES		<b>Auxiliary Contacts</b>										
		<b>Contact Type</b>	<b>Number of Contacts</b>	<b>Continuous Amp Rating</b>	<b>Voltage Rating</b>	<b>Maximum Number of Auxiliary Contacts per Disconnect Switch Part Number</b>			<b>Part Number</b>			
		NO	1	10A	600Vac	RDF30CC-_: 4 / 8 with BAC-HOLDER2			BAC05 <sup>(1)</sup>			
		NC	1	10A	600Vac	RDF30J-_-COMP: 2 / 6 with BAC-HOLDER2			BAC06 <sup>(1)</sup>			
		Auxiliary Contact Holder				Accepts 4 Auxiliary Contacts: BAC05 or BAC06			BAC-HOLDER2 <sup>(2)</sup>			

# UL 98 Fused Rotary Disconnect Switches—30A

Compact Class CC & Class J

**Dimensions – in (mm)**

- RDF30CC-

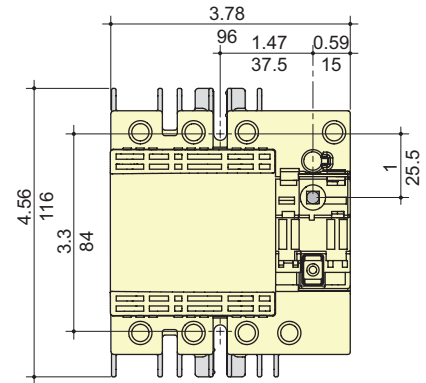
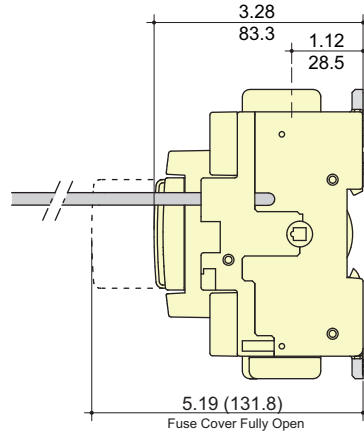

- RDF30J-   -COMP

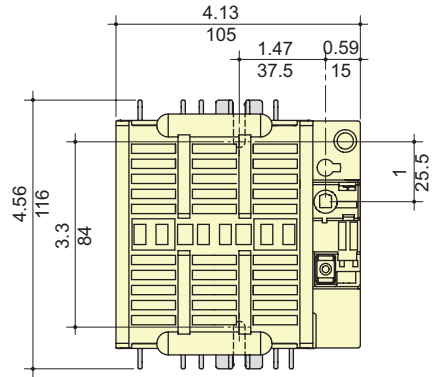
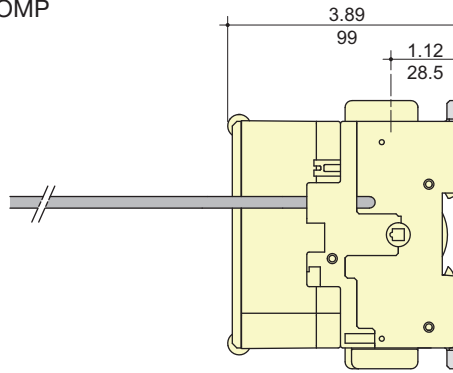

**External Front Selector Handle**

Selector Handle Type

Direction of Front Operation

Door Drilling Layout

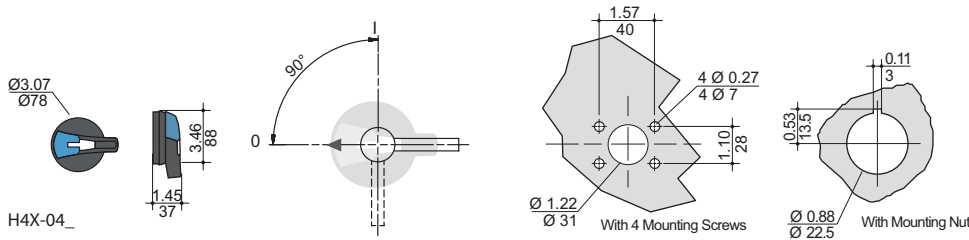

**External Front Pistol Handles**

Pistol Handle Type

Direction of Front Operation

Door Drilling Layout

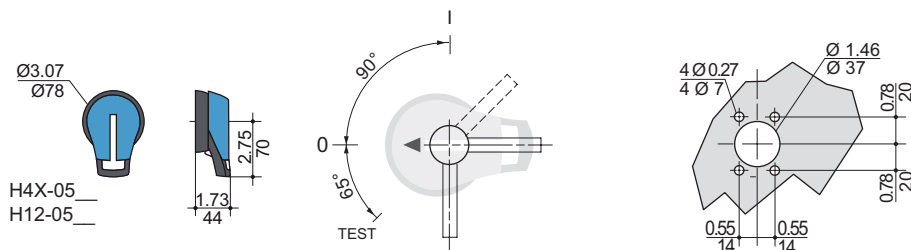

# UL 98 Fused Rotary Disconnect Switches—30A

Standard Class J

For a Complete Assembly, Please Select:

SWITCH		<b>Switch</b>												
		<b>Amp Rating</b>	<b>Fuse Class</b>	<b>No. of Poles</b>	<b>SCCR</b>	<b>Max Horsepower Rating</b>					<b>Wire Size</b>	<b>Wire Type</b>	<b>Part Number</b>	
					<b>1-Phase 220/240Vac</b>	<b>220/240Vac</b>	<b>3-Phase 440/480Vac</b>	<b>600 Vac</b>	<b>DC*</b>					
									<b>125 Vdc</b>	<b>250 Vdc</b>				
		30	J	2	200kA	3	-	-	-	3	5	#14-10 Sol #14-6 Str	75°C Cu	RDF30J-2
		30	J	3	200kA	-	7.5	15	20	3	5	#14-10 Sol #14-6 Str	75°C Cu	RDF30J-3
		30	J	4	200kA	-	7.5	15	20	3	5	#14-10 Sol #14-6 Str	75°C Cu	RDF30J-4
		* DC Ratings use two poles in series.												
		+												
	HANDLE		<b>Direct Mount Handle - mounts directly to switch, no shaft required</b>											
		<b>For Switch Part Number</b>		<b>Color</b>	<b>Test Function</b>	<b>Padlockable</b>						<b>Part Number</b>		
		All Switches		Black	Y	Y - On Switch						DIR-07		
		or												
		<b>External Front Operated Pistol Handles - shaft required</b>												
		<b>NEMA Type</b>	<b>Color</b>	<b>Test Function</b>	<b>Padlockable</b>	<b>Defeatable</b>						<b>Part Number</b>		
		1, 3R, 12	Black	N	Y	Y						H12-05B		
		1, 3R, 12	Red/Yellow	N	Y	Y						H12-05R		
		1, 3R, 4, 4X, 12	Black	N	Y	Y						H4X-05B		
		1, 3R, 4, 4X, 12	Red/Yellow	N	Y	Y						H4X-05R		
	1, 3R, 4, 4X, 12	Black	Y	Y	Y						H4X-05TB			
	1, 3R, 4, 4X, 12	Red/Yellow	Y	Y	Y						H4X-05TR			
or		<b>Metallic Hasp (Heavy Duty) External Front Operated Pistol Handles - shaft required</b>												
	<b>NEMA Type</b>	<b>Color</b>	<b>Test Function</b>	<b>Padlockable</b>	<b>Defeatable</b>						<b>Part Number</b>			
	1, 3R, 4, 4X, 12	Black	N	Y	Y						H4X-05BHD			
	1, 3R, 4, 4X, 12	Red/Yellow	N	Y	Y						H4X-05RHD			
	<b>External Right Side Operated Pistol Handles - shaft required</b>													
	<b>NEMA Type</b>	<b>Color</b>	<b>Test Function</b>	<b>Padlockable</b>	<b>Defeatable</b>						<b>Part Number</b>			
	1, 3R, 4, 4X, 12	Black	N	Y	N/A						H4X-05SB			
	1, 3R, 4, 4X, 12	Red/Yellow	N	Y	N/A						H4X-05SR			
	<b>Shafts for Pistol Handles</b>													
	<b>Length in (mm)</b>	<b>Mounting Depth (X) in (mm)</b>							<b>Part Number</b>					
	7.9 (200)	5.30~9.06 (135~230)							SH5-200					
	12.6 (320)	5.30~13.78 (135~350)							SH5-320					
	15.7 (400)	5.30~16.93 (135~430)							SH5-400					
	or													
	<b>Flange Handle<sup>(1)</sup> - requires shaft operated mechanism or cable operated mechanism + cable</b>													
	<b>NEMA Type</b>	<b>Flange Style</b>	<b>Test Function</b>	<b>Padlockable</b>	<b>Defeatable</b>						<b>Part Number</b>			
	1, 3R, 4, 12	Standard	N	Y	Y						FLH1			
	1, 3R, 4, 4X, 12	Chrome Plated	N	Y	Y						FLH2			
	<b>Shaft Operated Flange Mechanism<sup>(2)</sup> - includes shaft</b>													
	<b>For Enclosure Depth - in (mm)</b>										<b>Part Number</b>			
	6~24 (152~613)										FLRM			
	<b>Cable Operated Flange Mechanism and Cable - must select Mechanism<sup>(3)</sup> and Cable<sup>(4)</sup></b>													
	<b>Item / Length</b>										<b>Part Number</b>			
	Cable Mechanism										FLCM			
	36" (900mm) Cable										FLC36			
	60" (1500mm) Cable										FLC60			
	120" (3000mm) Cable										FLC120			
	or													
	<b>NFPA Through the Door Handle Kit - to be used with front pistol handle</b>													
	<b>Color</b>	<b>Test Function</b>	<b>Padlockable</b>	<b>Defeatable</b>								<b>Part Number</b>		
	Red	N	Y	N								H79-2		

# UL 98 Fused Rotary Disconnect Switches—30A

## Standard Class J

and ...

ACC. AUX CONTACTS		Auxiliary Contacts				Max Number of Aux Contacts per Switch	Part Number
		Contact Type	Number of Contacts	Continuous Amp Rating	Voltage Rating		
		NO	1	10A	600Vac	4	BAC05
		NC	1	10A	600Vac	4	BAC06

### Dimensions – in (mm)

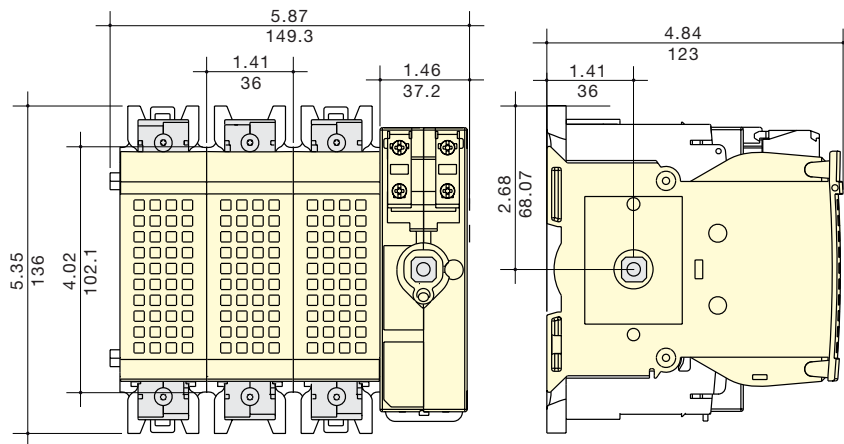

### Direct Mount Handle

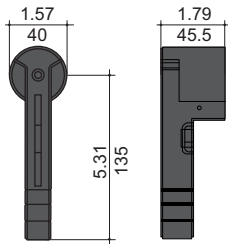

DIR-07

### Flange Handle

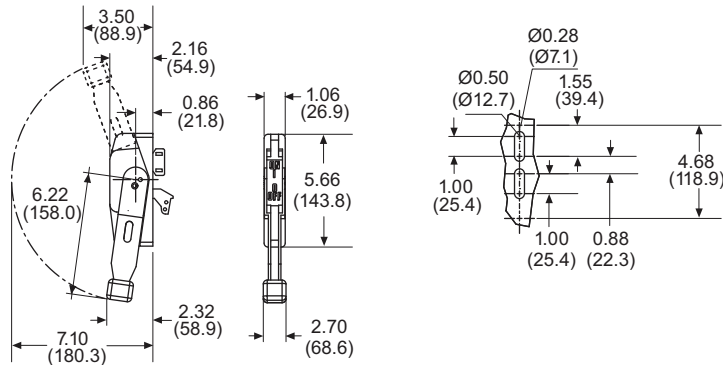

FLH\_

### External Front & Right Side Pistol Handle

Handle Type

Direction of Front Operation

Direction of Right Side Operation

Door Drilling Layout

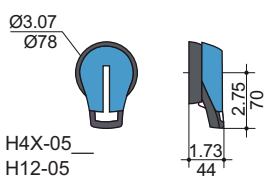



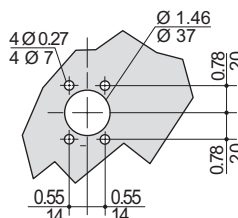
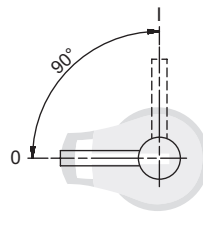
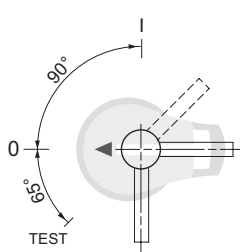

H4X-05  
H12-05



# UL 98 Fused Rotary Disconnect Switches—60A

Compact Class J

For a Complete Assembly, Please Select:

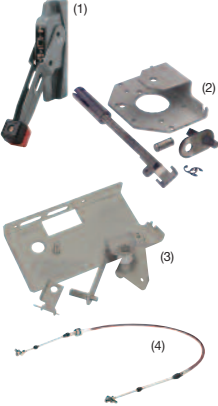
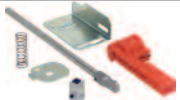
SWITCH		<b>Switch</b>																																																																					
		<table border="1"> <thead> <tr> <th rowspan="2">Amp Rating</th> <th rowspan="2">Fuse Class</th> <th rowspan="2">Number of Poles</th> <th rowspan="2">SCCR</th> <th colspan="4">Max Horsepower Rating</th> <th colspan="2">DC*</th> <th rowspan="2">Wire Size</th> <th rowspan="2">Wire Type</th> <th rowspan="2">Part Number</th> </tr> <tr> <th>1-Phase 220/240Vac</th> <th>3-Phase 220/240Vac</th> <th>440/480Vac</th> <th>600 Vac</th> <th>125 Vdc</th> <th>250 Vdc</th> </tr> </thead> <tbody> <tr> <td>60</td> <td>J</td> <td>2</td> <td>100kA</td> <td>10</td> <td>-</td> <td>-</td> <td>-</td> <td>5</td> <td>10</td> <td>#14-10 Sol #14-6 Str</td> <td>75°C Cu</td> <td>RDF60J-2-COMP</td> </tr> <tr> <td>60</td> <td>J</td> <td>3</td> <td>100kA</td> <td>-</td> <td>15</td> <td>30</td> <td>50</td> <td>5</td> <td>10</td> <td>#14-10 Sol #14-6 Str</td> <td>75°C Cu</td> <td>RDF60J-3-COMP</td> </tr> <tr> <td>60</td> <td>J</td> <td>4</td> <td>100kA</td> <td>-</td> <td>15</td> <td>30</td> <td>50</td> <td>5</td> <td>10</td> <td>#14-10 Sol #14-6 Str</td> <td>75°C Cu</td> <td>RDF60J-4-COMP</td> </tr> </tbody> </table>	Amp Rating	Fuse Class	Number of Poles	SCCR	Max Horsepower Rating				DC*		Wire Size	Wire Type	Part Number	1-Phase 220/240Vac	3-Phase 220/240Vac	440/480Vac	600 Vac	125 Vdc	250 Vdc	60	J	2	100kA	10	-	-	-	5	10	#14-10 Sol #14-6 Str	75°C Cu	RDF60J-2-COMP	60	J	3	100kA	-	15	30	50	5	10	#14-10 Sol #14-6 Str	75°C Cu	RDF60J-3-COMP	60	J	4	100kA	-	15	30	50	5	10	#14-10 Sol #14-6 Str	75°C Cu	RDF60J-4-COMP	* DC Ratings use two poles in series.										
							Amp Rating	Fuse Class	Number of Poles	SCCR	Max Horsepower Rating					DC*		Wire Size	Wire Type	Part Number																																																			
			1-Phase 220/240Vac	3-Phase 220/240Vac	440/480Vac	600 Vac					125 Vdc	250 Vdc																																																											
	60	J	2	100kA	10	-	-	-	5	10	#14-10 Sol #14-6 Str	75°C Cu	RDF60J-2-COMP																																																										
	60	J	3	100kA	-	15	30	50	5	10	#14-10 Sol #14-6 Str	75°C Cu	RDF60J-3-COMP																																																										
	60	J	4	100kA	-	15	30	50	5	10	#14-10 Sol #14-6 Str	75°C Cu	RDF60J-4-COMP																																																										
	+																																																																						
	HANDLE		<b>Direct Mount Handle - mounts directly to switch, no shaft required</b>																																																																				
			For Switch Part Number	Color	Test Function	Padlockable				Part Number																																																													
All Switches										Black	Y	Y - On Switch		DIR-07																																																									
or																																																																							
 or  + 		<b>External Front Operated Pistol Handles - shaft required</b>																																																																					
		NEMA Type	Color	Test Function	Padlockable	Defeatable				Part Number																																																													
		1, 3R, 12	Black	N	Y	Y				H12-05B																																																													
		1, 3R, 12	Red/Yellow	N	Y	Y				H12-05R																																																													
		1, 3R, 4, 4X, 12	Black	N	Y	Y				H4X-05B																																																													
		1, 3R, 4, 4X, 12	Red/Yellow	N	Y	Y				H4X-05R																																																													
	1, 3R, 4, 4X, 12	Black	Y	Y	Y				H4X-05TB																																																														
	1, 3R, 4, 4X, 12	Red/Yellow	Y	Y	Y				H4X-05TR																																																														
	<b>Metallic Hasp (Heavy Duty) External Front Operated Pistol Handles - shaft required</b>																																																																						
	NEMA Type	Color	Test Function	Padlockable	Defeatable				Part Number																																																														
1, 3R, 4, 4X, 12	Black	N	Y	Y				H4X-05BHD																																																															
1, 3R, 4, 4X, 12	Red/Yellow	N	Y	Y				H4X-05RHD																																																															
<b>External Right Side Operated Pistol Handles - shaft required</b>																																																																							
NEMA Type	Color	Test Function	Padlockable	Defeatable				Part Number																																																															
1, 3R, 4, 4X, 12	Black	N	Y	N/A				H4X-05SB																																																															
1, 3R, 4, 4X, 12	Red/Yellow	N	Y	N/A				H4X-05SR																																																															
<b>Shafts for Pistol Handles</b>																																																																							
Length in (mm)	Mounting Depth (X) in (mm)							Part Number																																																															
7.9 (200)	5.30~9.06 (135~230)							SH5-200																																																															
12.6 (320)	5.30~13.78 (135~350)							SH5-320																																																															
15.7 (400)	5.30~16.93 (135~430)							SH5-400																																																															
OR																																																																							
	<b>Flange Handle<sup>(1)</sup> - requires shaft operated mechanism or cable operated mechanism + cable</b>																																																																						
	NEMA Type	Flange Style	Test Function	Padlockable	Defeatable				Part Number																																																														
	1, 3R, 4, 12	Standard	N	Y	Y				FLH1																																																														
	1, 3R, 4, 4X, 12	Chrome Plated	N	Y	Y				FLH2																																																														
	<b>Shaft Operated Flange Mechanism<sup>(2)</sup> - includes shaft</b>																																																																						
	For Enclosure Depth - in (mm)								Part Number																																																														
	6-24 (152~613)								FLRM																																																														
	<b>Cable Operated Flange Mechanism and Cable - must select Mechanism<sup>(3)</sup> and Cable<sup>(4)</sup></b>																																																																						
	Item / Length								Part Number																																																														
	Cable Mechanism								FLCM																																																														
36" (900mm) Cable								FLC36																																																															
60" (1500mm) Cable								FLC60																																																															
120" (3000mm) Cable								FLC120																																																															
OR																																																																							
	<b>NFPA Through the Door Handle Kit - to be used with selector handle or front pistol handle</b>																																																																						
	Color				Test Function	Padlockable	Defeatable				Part Number																																																												
Red											N	Y	N	H79-2																																																									

# UL 98 Fused Rotary Disconnect Switches—60A

## Compact Class J

and ...

Acc.	AUX CONTACTS		Auxillary Contacts				Part Number	
			Contact Type	Number of Contacts	Continuous Amp Rating	Voltage Rating		Max Number of Aux Contacts per Switch
			NO	1	10A	600Vac	4	BAC05
			NC	1	10A	600Vac	4	BAC06

Dimensions – in (mm)

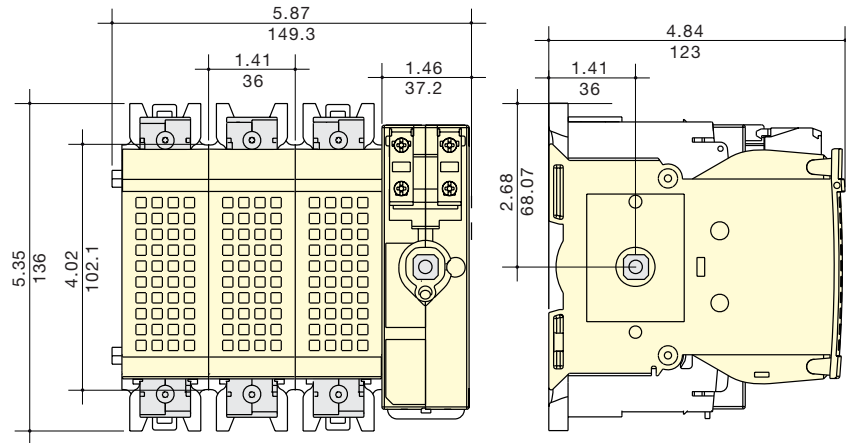

Direct Mount Handle

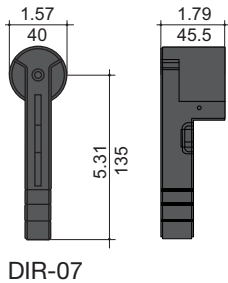

Flange Handle

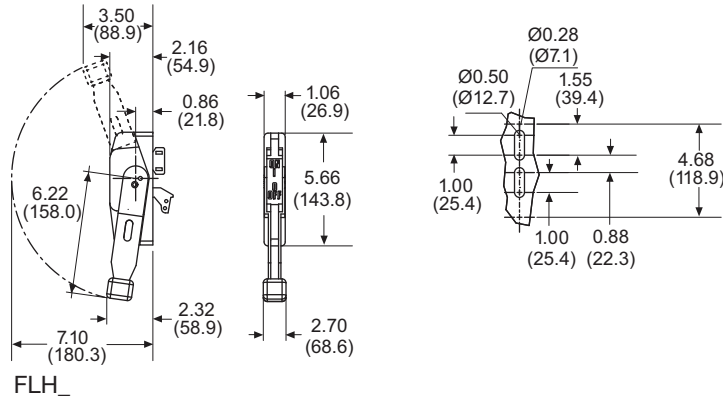



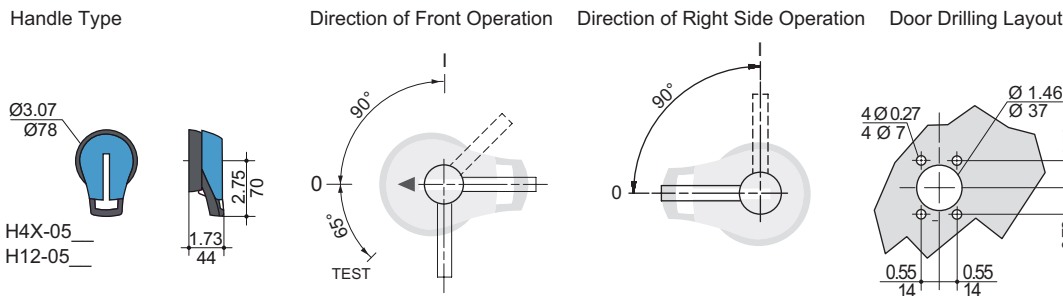

External Front & Right Side Pistol Handle



# UL 98 Fused Rotary Disconnect Switches—60A

Standard Class J

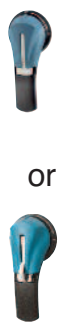
For a Complete Assembly, Please Select:

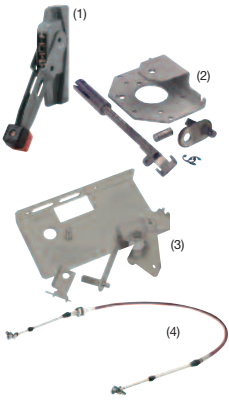
SWITCH		<b>Switch</b>												
		<b>Amp Rating</b>	<b>Fuse Class</b>	<b>Number of Poles</b>	<b>SCCR</b>	<b>Max Horsepower Rating</b>						<b>Wire Size</b>	<b>Wire Type</b>	<b>Part Number</b>
						<b>1-Phase 220/240Vac</b>	<b>3-Phase 220/240Vac</b>	<b>440/480Vac</b>	<b>600 Vac</b>	<b>DC*</b>				
		60	J	2	200kA	10	-	-	-	5	10	#12-10 Sol #12-1 Str	75°C Cu	RDF60J-2
60	J	3	200kA	-	15	30	50	5	10	#12-10 Sol #12-1 Str	75°C Cu	RDF60J-3		
60	J	4	200kA	-	15	30	50	5	10	#12-10 Sol #12-1 Str	75°C Cu	RDF60J-4		
* DC Ratings use two poles in series.														
+														
HANDLE		<b>Direct Mount Handle - mounts directly to switch, no shaft required</b>												
		<b>For Switch Part Number</b>	<b>Color</b>	<b>Test Function</b>	<b>Padlockable</b>							<b>Part Number</b>		
		All Switches	Black	Y	Y							DIR-07		
OR														
Select for Standard Applications		<b>External Front Operated Pistol Handles - shaft required</b>												
		<b>NEMA Type</b>	<b>Color</b>	<b>Test Function</b>	<b>Padlockable</b>	<b>Defeatable</b>							<b>Part Number</b>	
		1, 3R, 12	Black	N	Y	Y							H12-03B	
		1, 3R, 12	Red/Yellow	N	Y	Y							H12-03R	
		1, 3R, 4, 4X, 12	Black	N	Y	Y							H4X-06B	
		1, 3R, 4, 4X, 12	Red/Yellow	N	Y	Y							H4X-06R	
		1, 3R, 4, 4X, 12	Black	Y	Y	Y							H4X-06TB	
		1, 3R, 4, 4X, 12	Red/Yellow	Y	Y	Y							H4X-06TR	
		<b>Metallic Hasp (Heavy Duty) External Front Operated Pistol Handles - shaft required</b>												
		<b>NEMA Type</b>	<b>Color</b>	<b>Test Function</b>	<b>Padlockable</b>	<b>Defeatable</b>							<b>Part Number</b>	
		1, 3R, 4, 4X, 12	Black	N	Y	Y							H4X-06BHD	
		1, 3R, 4, 4X, 12	Red/Yellow	N	Y	Y							H4X-06RHD	
<b>External Right Side Operated Pistol Handles - shaft required</b>														
<b>NEMA Type</b>	<b>Color</b>	<b>Test Function</b>	<b>Padlockable</b>	<b>Defeatable</b>							<b>Part Number</b>			
1, 3R, 4, 4X, 12	Black	N	Y	N/A							H4X-06SB			
1, 3R, 4, 4X, 12	Red/Yellow	N	Y	N/A							H4X-06SR			
<b>Shafts for Pistol Handles</b>														
<b>Length in (mm)</b>	<b>Mounting Depth (X) in (mm)</b>										<b>Part Number</b>			
7.9 (200)	5.30~9.06 (135~230)											SH5-200		
12.6 (320)	5.30~13.78 (135~350)											SH5-320		
15.7 (400)	5.30~16.93 (135~430)											SH5-400		
OR														
	<b>Flange Handle<sup>(1)</sup> - requires shaft operated mechanism or cable operated mechanism + cable</b>													
	<b>NEMA Type</b>	<b>Flange Style</b>	<b>Test Function</b>	<b>Padlockable</b>	<b>Defeatable</b>							<b>Part Number</b>		
	1, 3R, 4, 12	Standard	N	Y	Y							FLH1		
	1, 3R, 4, 4X, 12	Chrome Plated	N	Y	Y							FLH2		
	<b>Shaft Operated Flange Mechanism<sup>(2)</sup> - includes shaft</b>													
	<b>For Enclosure Depth in (mm)</b>											<b>Part Number</b>		
	6~24 (152~613)											FLRM		
	<b>Cable Operated Flange Mechanism and Cable - must select Mechanism<sup>(3)</sup> and Cable<sup>(4)</sup></b>													
	<b>Item / Length</b>											<b>Part Number</b>		
	Cable Mechanism											FLCM		
36" (900mm) Cable											FLC36			
60" (1500mm) Cable											FLC60			
120" (3000mm) Cable											FLC120			



# UL 98 Fused Rotary Disconnect Switches—60A

Standard Class J

Select		or					
NFPA HANDLE		<b>NFPA Through the Door Handle Kit - to be used with front pistol handle</b>					
		<b>Color</b>		<b>Test Function</b>	<b>Padlockable</b>	<b>Defeatable</b>	<b>Part Number</b>
		Red		N	Y	N	H79-2
Acc.		and ...					
AUX CONTACTS		<b>Auxiliary Contacts</b>					
		<b>Contact Type</b>	<b>Number of Contacts</b>	<b>Continuous Amp Rating</b>	<b>Voltage Rating</b>	<b>Max Number of Aux Contacts per Switch</b>	<b>Part Number</b>
		NO	1	10A	600Vac	4	BAC05
NC	1	10A	600Vac	4	BAC06		

Dimensions – in (mm)

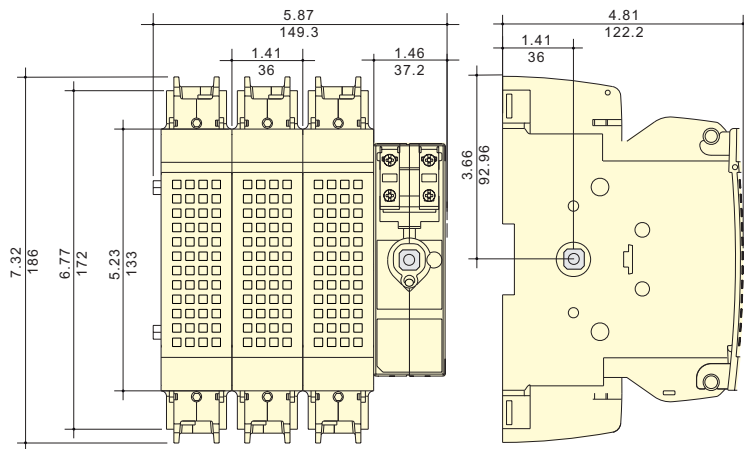

Direct Mount Handle

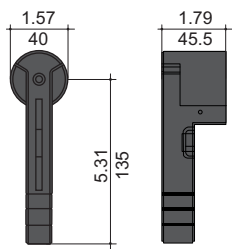

DIR-07

Flange Handle

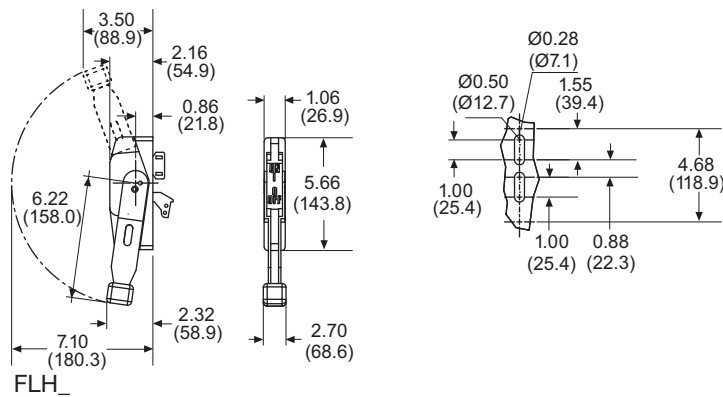

FLH\_

External Front and Right Side Pistol Handle

Handle Type      Direction of Front Operation      Direction of Right Side Operation      Door Drilling Layout

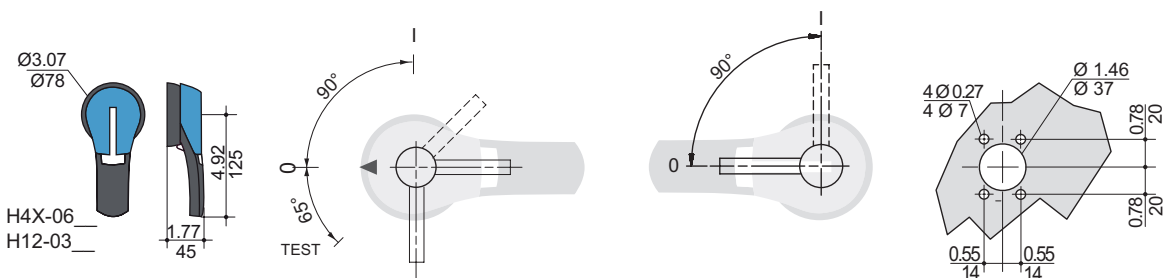



H4X-06  
H12-03

# UL 98 Fused Rotary Disconnect Switches – 100A

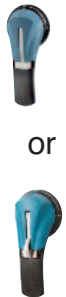
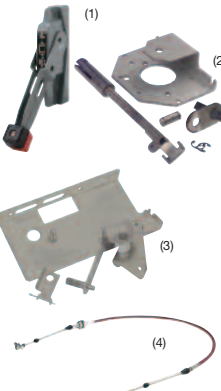

Standard Class J

For a Complete Assembly, Please Select:

SWITCH		<b>Switch</b>												
		<b>Amp Rating</b>	<b>Fuse Class</b>	<b>Number of Poles</b>	<b>SCCR</b>	<b>Max Horsepower Rating</b>						<b>Wire Size</b>	<b>Wire Type</b>	<b>Part Number</b>
						<b>1-Phase 220/240Vac</b>	<b>220/240Vac</b>	<b>440/480Vac</b>	<b>600 Vac</b>	<b>DC*</b>				
		100	J	2	200kA	10	-	-	-	7.5	20	#12-10 Sol #12-1 Str	75°C Cu	RDF100J-2
100	J	3	200kA	-	30	60	75	7.5	20	#12-10 Sol #12-1 Str	75°C Cu	RDF100J-3		
100	J	4	200kA	-	30	60	75	7.5	20	#12-10 Sol #12-1 Str	75°C Cu	RDF100J-4		
* DC Ratings use two poles in series.														
+														
HANDLE		<b>Direct Mount Handle - mounts directly to switch, no shaft required</b>												
		<b>For Switch Part Number</b>	<b>Color</b>	<b>Test Function</b>	<b>Padlockable</b>							<b>Part Number</b>		
		All Switches	Black	Y	Y							DIR-07		
or														
Select for Standard Applications		<b>External Front Operated Pistol Handles - shaft required</b>												
		<b>NEMA Type</b>	<b>Color</b>	<b>Test Function</b>	<b>Padlockable</b>	<b>Defeatable</b>							<b>Part Number</b>	
		1, 3R, 12	Black	N	Y	Y							H12-03B	
		1, 3R, 12	Red/Yellow	N	Y	Y							H12-03R	
		1, 3R, 4, 4X, 12	Black	N	Y	Y							H4X-06B	
		1, 3R, 4, 4X, 12	Red/Yellow	N	Y	Y							H4X-06R	
		1, 3R, 4, 4X, 12	Black	Y	Y	Y							H4X-06TB	
		1, 3R, 4, 4X, 12	Red/Yellow	Y	Y	Y							H4X-06TR	
		<b>Metallic Hasp (Heavy Duty) External Front Operated Pistol Handles - shaft required</b>												
		<b>NEMA Type</b>	<b>Color</b>	<b>Test Function</b>	<b>Padlockable</b>	<b>Defeatable</b>							<b>Part Number</b>	
		1, 3R, 4, 4X, 12	Black	N	Y	Y							H4X-06BHD	
		1, 3R, 4, 4X, 12	Red/Yellow	N	Y	Y							H4X-06RHD	
		<b>External Right Side Operated Pistol Handles - shaft required</b>												
		<b>NEMA Type</b>	<b>Color</b>	<b>Test Function</b>	<b>Padlockable</b>	<b>Defeatable</b>							<b>Part Number</b>	
		1, 3R, 4, 4X, 12	Black	N	Y	N/A							H4X-06SB	
1, 3R, 4, 4X, 12	Red/Yellow	N	Y	N/A							H4X-06SR			
<b>Shafts for Pistol Handles</b>														
<b>Length in (mm)</b>	<b>Mounting Depth (X) in (mm)</b>								<b>Part Number</b>					
7.9 (200)	5.30~9.06 (135~230)								SH5-200					
12.6 (320)	5.30~13.78 (135~350)								SH5-320					
15.7 (400)	5.30~16.93 (135~430)								SH5-400					
or														
Select for Standard Applications		<b>Flange Handle<sup>(1)</sup> - requires shaft operated mechanism or cable operated mechanism + cable</b>												
		<b>NEMA Type</b>	<b>Flange Style</b>	<b>Test Function</b>	<b>Padlockable</b>	<b>Defeatable</b>							<b>Part Number</b>	
		1, 3R, 4, 12	Standard	N	Y	Y							FLH1	
		1, 3R, 4, 4X, 12	Chrome Plated	N	Y	Y							FLH2	
		<b>Shaft Operated Flange Mechanism<sup>(2)</sup> - includes shaft</b>												
		<b>For Enclosure Depth in (mm)</b>							<b>Part Number</b>					
		6~24 (152~613)							FLRM					
		<b>Cable Operated Flange Mechanism and Cable - must select Mechanism<sup>(3)</sup> and Cable<sup>(4)</sup></b>												
		<b>Item / Length</b>							<b>Part Number</b>					
		Cable Mechanism							FLCM					
36" (900mm) Cable							FLC36							
60" (1500mm) Cable							FLC60							
120" (3000mm) Cable							FLC120							

# UL 98 Fused Rotary Disconnect Switches – 100A

Standard Class J

Select		or					
NFPA HANDLE		<b>NFPA Through the Door Handle Kit - to be used with front pistol handle</b>					
		<b>Color</b>		<b>Test Function</b>	<b>Padlockable</b>	<b>Defeatable</b>	<b>Part Number</b>
		Red		N	Y	N	H79-2
Acc.		and ...					
AUX CONTACTS		<b>Auxiliary Contacts</b>					
		<b>Contact Type</b>	<b>Number of Contacts</b>	<b>Continuous Amp Rating</b>	<b>Voltage Rating</b>	<b>Max Number of Aux Contacts per Switch</b>	<b>Part Number</b>
		NO	1	10A	600Vac	4	BAC05
		NC	1	10A	600Vac	4	BAC06

Dimensions – in (mm)

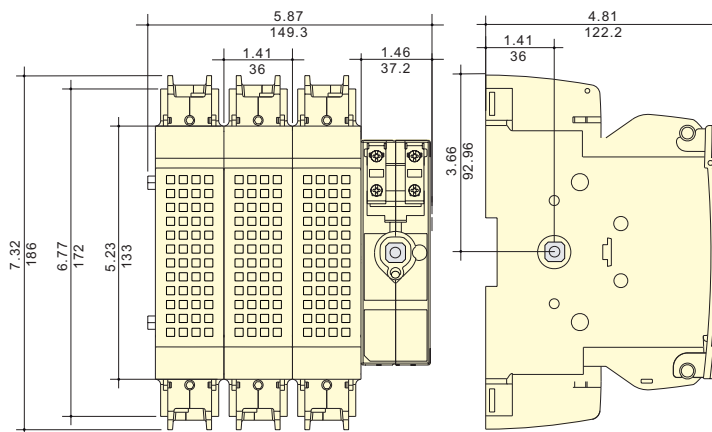

Direct Mount Handle

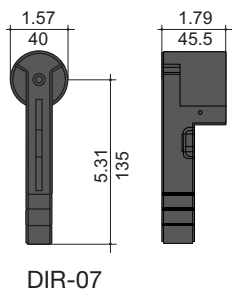

Flange Handle

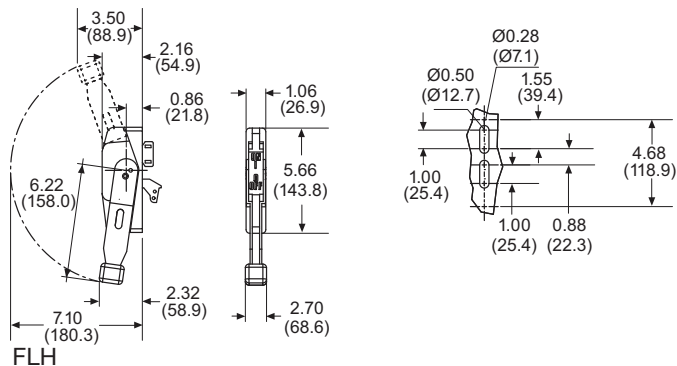

External Front & Right Side Pistol Handle

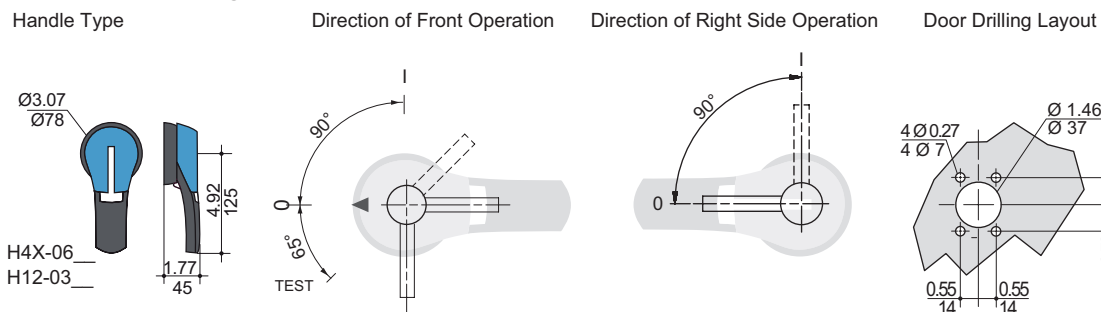

# UL 98 Fused Rotary Disconnect Switches—200 & 400A



Standard Class J

For a Complete Assembly, Please Select:

SWITCH + LUGS		<b>Switch</b>										
		<b>Amp Rating</b>	<b>Fuse Class</b>	<b>Number of Poles</b>	<b>SCCR</b>	<b>Max Horsepower Rating</b>				<b>DC*</b>		<b>Part Number</b>
						<b>1-Phase 220/240Vac</b>	<b>220/240Vac</b>	<b>3-Phase 440/480Vac</b>	<b>600 Vac</b>	<b>125 Vdc</b>	<b>250 Vdc</b>	
		200	J	2	200kA	10	-	-	-	-	-	RDF200J-2
		200	J	3	200kA	-	60	125	150	-	-	RDF200J-3
		200	J	4	200kA	-	60	125	150	-	-	RDF200J-4
		400	J	2	200kA	10	-	-	-	20	50	RDF400J-2
		400	J	3	200kA	-	125	250	350	20	50	RDF400J-3
		400	J	4	200kA	-	125	250	350	20	50	RDF400J-4
		* DC Ratings use two poles in series.										
Terminal Lug Kit		<b>Terminal Lug Kit</b>										
		<b>Switch Amp Rating</b>	<b>Number of Poles</b>	<b>Lugs Per Kit</b>	<b>Wire Range</b>			<b>Wire Type</b>		<b>Part Number</b>		
					<b>200</b>	<b>200</b>	<b>200</b>	<b>400</b>	<b>400</b>		<b>400</b>	
		200	2	2	#6-300MCM			75°C Cu/Al		LUG1-2		
		200	3	3	#6-300MCM			75°C Cu/Al		LUG1-3		
		200	4	4	#6-300MCM			75°C Cu/Al		LUG1-4		
		400	2	2	#4-600MCM or Dual 1/0-250MCM			75°C Cu/Al		LUG2-2		
400	3	3	#4-600MCM or Dual 1/0-250MCM			75°C Cu/Al		LUG2-3				
400	4	4	#4-600MCM or Dual 1/0-250MCM			75°C Cu/Al		LUG2-4				
Direct Mount Handle		<b>Direct Mount Handle - mounts directly to switch, no shaft required</b>										
		<b>For Switch Part Number</b>	<b>Color</b>	<b>Test Function</b>	<b>Padlockable</b>						<b>Part Number</b>	
All Switches	Black	Y	Y						DIR-07			
HANDLE	 or  or  + 	<b>External Front Operated Pistol Handles - shaft required</b>										
		<b>NEMA Type</b>	<b>Color</b>	<b>Test Function</b>	<b>Padlockable</b>	<b>Defeatable</b>	<b>Part Number</b>					
		1, 3R, 12	Black	N	Y	Y	H12-03B					
		1, 3R, 12	Red/Yellow	N	Y	Y	H12-03R					
		1, 3R, 4, 4X, 12	Black	N	Y	Y	H4X-06B					
		1, 3R, 4, 4X, 12	Red/Yellow	N	Y	Y	H4X-06R					
		1, 3R, 4, 4X, 12	Black	Y	Y	Y	H4X-06TB					
		1, 3R, 4, 4X, 12	Red/Yellow	Y	Y	Y	H4X-06TR					
		<b>Metallic Hasp (Heavy Duty) External Front Operated Pistol Handles - shaft required</b>										
		<b>NEMA Type</b>	<b>Color</b>	<b>Test Function</b>	<b>Padlockable</b>	<b>Defeatable</b>	<b>Part Number</b>					
		1, 3R, 4, 4X, 12	Black	N	Y	Y	H4X-06BHD					
		1, 3R, 4, 4X, 12	Red/Yellow	N	Y	Y	H4X-06RHD					
		<b>External Right Side Operated Pistol Handles - shaft required</b>										
		<b>NEMA Type</b>	<b>Color</b>	<b>Test Function</b>	<b>Padlockable</b>	<b>Defeatable</b>	<b>Part Number</b>					
		1, 3R, 4, 4X, 12	Black	N	Y	N/A	H4X-06SB					
		1, 3R, 4, 4X, 12	Red/Yellow	N	Y	N/A	H4X-06SR					
		<b>Shafts for Pistol Handles</b>										
		<b>Length in (mm)</b>	<b>Mounting Depth (X) in (mm)</b>									<b>Part Number</b>
		7.9 (200)	200A: 5.70-9.06 (145-230) 400A: 7.87-10.24 (200-260)									SH5-200
		12.6 (320)	200A: 5.70-13.78 (145-350) 400A: 7.87-16.93 (200-380)									SH5-320
15.7 (400)	200A: 5.70-16.93 (145-430) 400A: 7.87-18.10 (200-460)		SH5-400									

# UL 98 Fused Rotary Disconnect Switches – 200 & 400A

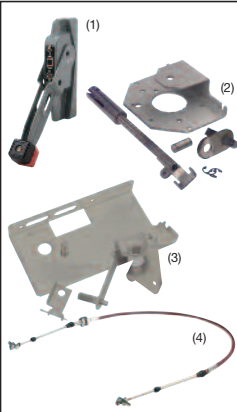
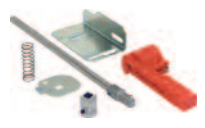
Standard Class J

Select for Standard Applications		or							
		<b>Flange Handle<sup>(1)</sup> 200A Only</b> - requires shaft operated mechanism <i>or</i> cable operated mechanism + cable							
		NEMA Type	Flange Style	Test Function	Padlockable	Defeatable	Part Number		
		1, 3R, 4, 12	Standard	N	Y	Y	FLH1		
		1, 3R, 4, 4X, 12	Chrome Plated	N	Y	Y	FLH2		
		<b>Shaft Operated Flange Mechanism<sup>(2)</sup> 200A Only</b> - includes shaft							
		For Enclosure Depth in (mm)					Part Number		
		6-24 (152-613)					FLRM		
		<b>Cable Operated Flange Mechanism and Cable 200A Only</b> - must select Mechanism <sup>(3)</sup> <i>and</i> Cable <sup>(4)</sup>							
		Item	Part Number						
Cable Mechanism	FLCM								
36" (900mm) Cable	FLC36								
60" (1500mm) Cable	FLC60								
120" (3000mm) Cable	FLC120								
Accessories		or							
		<b>NFPA Through the Door Handle Kit</b> - to be used with front pistol handle							
		Use with Switch	Color	Test Function	Padlockable	Defeatable	Part Number		
		RDF200J-__	Red	N	Y	N	H79-2		
		RDF400J-__	Red	N	Y	N	H79-3		
		and ...							
		Accessories		<b>Auxiliary Contacts</b>					
				Contact Type	Number of Contacts	Continuous Amp Rating	Voltage Rating	Max Number of Aux Contacts per Switch	Part Number
				NO	1	10A	600Vac	RDF200J-__: 4	BAC05
				NC	1	10A	600Vac	RDF400J-__: 8	BAC06
and ...									
Accessories				<b>Terminal Shrouds</b> - includes terminal shroud for lineside or loadside					
				Switch Amp Rating	Number of Poles				Part Number
				200	2				TSH8-2TB
				200	3				TSH8-3TB
				200	4				TSH8-4TB
		400	2				TSH9-2TB		
		400	3				TSH9-3TB		
		400	4				TSH9-4TB		

Dimensions – in (mm)

• RDF200J-3

• RDF400J-3

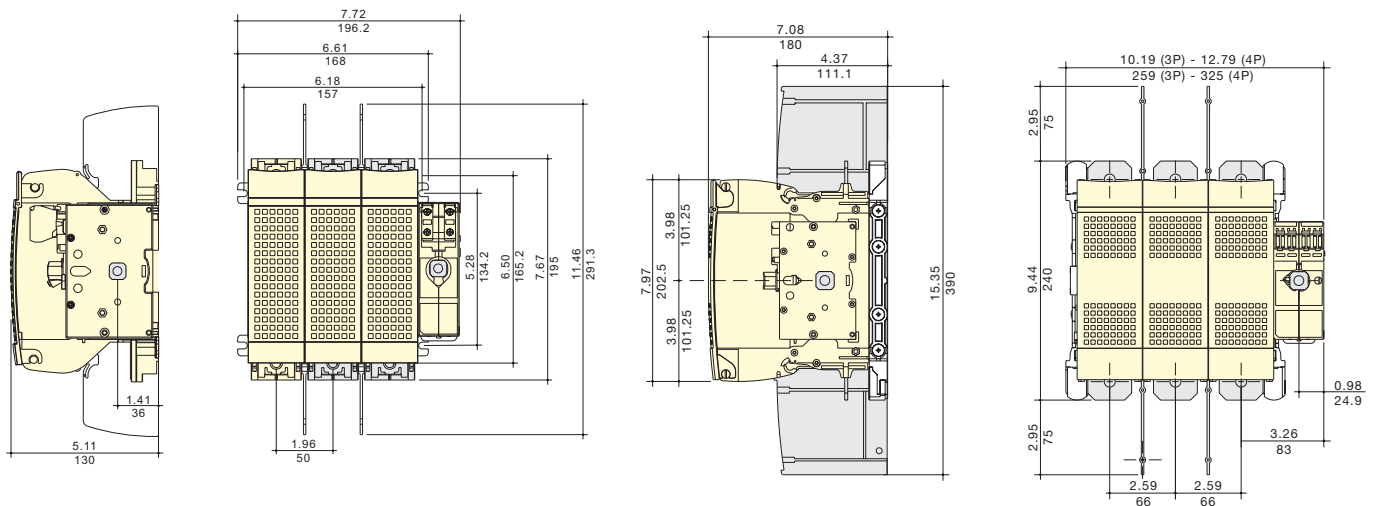

# UL 98 Fused Rotary Disconnect Switches—200 & 400A

## Standard Class J

### Direct Mount Handle

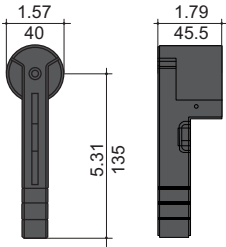

DIR-07

### Flange Handle

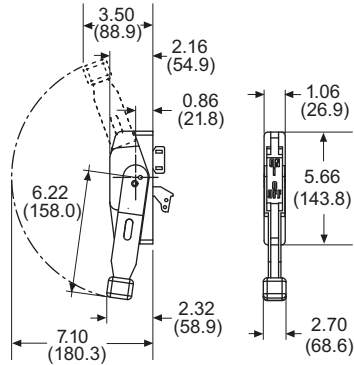

FLH\_

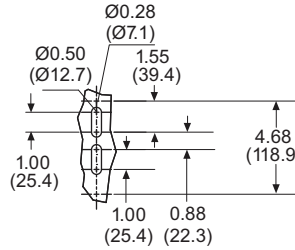

### External Front & Right Side Pistol Handle

Handle Type

Direction of Front Operation

Direction of Right Side Operation

Door Drilling Layout

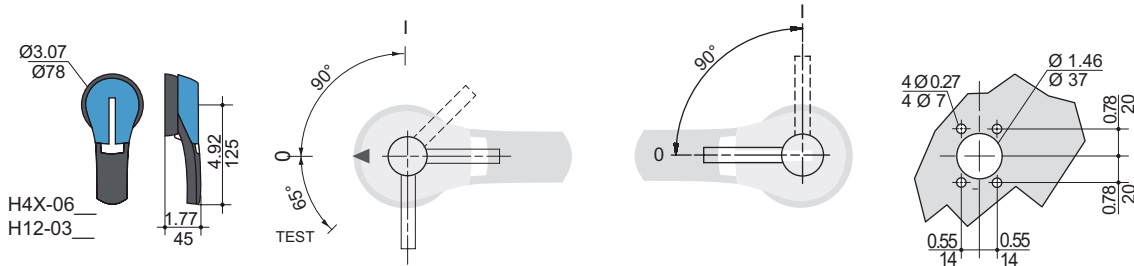

### Terminal Lugs

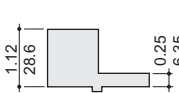
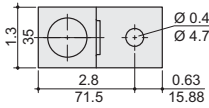
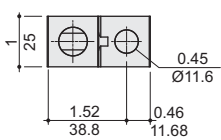

200A

LUG1-\_\_



400A

LUG2-\_\_



## Open & Enclosed Rotary Disconnect Switches In-Stock and Ship Within 24 Hours

The Bussmann QuikShip Everyday Service ensures the most common open and enclosed rotary disconnect switches ship within 24 hours to help you meet project timelines.

Contact your Bussmann representative for details.



**QuikShip**   
Everyday



[www.cooperbussmann.com/Disconnects](http://www.cooperbussmann.com/Disconnects)



# UL 98 Fused Rotary Disconnect Switches—600 & 800A

Standard Class J & Class L

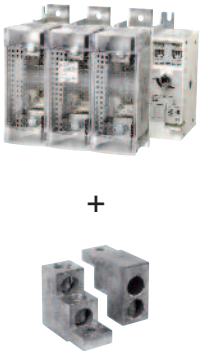
For a Complete Assembly, Please Select:

Select for Standard Applications		<b>Switch</b>							
		<b>Amp Rating</b>	<b>Fuse Class</b>	<b>Number of Poles</b>	<b>SCCR</b>	<b>Max Horsepower Rating, 3-Phase</b>			<b>Part Number</b>
						<b>220/240Vac</b>	<b>440/480Vac</b>	<b>600Vac</b>	
		600	J	2	200kA	-	-	-	RDF600J-2
		600	J	3	200kA	200	400	500	RDF600J-3
		600	J	4	200kA	200	400	500	RDF600J-4
		800	L	2	200kA	-	-	-	RDF800L-2
		800	L	3	200kA	200	500	500	RDF800L-3
		800	L	4	200kA	200	500	500	RDF800L-4
		<b>Terminal Lug Kit</b>							
<b>Switch Amp Rating</b>	<b>Number of Poles</b>	<b>Lugs Per Kit</b>	<b>Wire Range</b>			<b>Wire Type</b>	<b>Part Number</b>		
600-800	2	2	(2) #2-600MCM			75°C Cu/Al	LUG5-2		
600-800	3	3	(2) #2-600MCM			75°C Cu/Al	LUG5-3		
600-800	4	4	(2) #2-600MCM			75°C Cu/Al	LUG5-4		
+									
Accessories		<b>Direct Mount Handle - mounts directly to switch, no shaft required</b>							
		<b>For Switch Part Number</b>		<b>Color</b>	<b>Test Function</b>	<b>Padlockable</b>		<b>Part Number</b>	
		All Switches		Black	Y	Y		DIR-08	
		OR							
		<b>External Front Operated Pistol Handles - shaft required</b>							
		<b>NEMA Type</b>		<b>Color</b>	<b>Test Function</b>	<b>Padlockable</b>	<b>Defeatable</b>	<b>Part Number</b>	
		1, 3R, 4, 4X, 12		Black	N	Y	Y	H4X-07B	
		1, 3R, 4, 4X, 12		Red/Yellow	N	Y	Y	H4X-07R	
		<b>Metallic Hasp (Heavy Duty) External Front Operated Pistol Handles - shaft required</b>							
		<b>NEMA Type</b>		<b>Color</b>	<b>Test Function</b>	<b>Padlockable</b>	<b>Defeatable</b>	<b>Part Number</b>	
1, 3R, 4, 4X, 12		Black	N	Y	Y	H4X-07BHD			
1, 3R, 4, 4X, 12		Red/Yellow	N	Y	Y	H4X-07RHD			
<b>Shafts for Pistol Handles</b>									
<b>Length in (mm)</b>	<b>Mounting Depth (X) in (mm)</b>					<b>Part Number</b>			
7.9 (200)	10.63~11.97 (270~304)					SH7-200			
12.6 (320)	10.63~16.69 (270~424)					SH7-320			
15.7 (400)	10.63~19.84 (270~504)					SH7-400			
OR									
Accessories		<b>NFPA Through the Door Handle Kit - to be used with front pistol handle</b>							
		<b>For Switch Part Number</b>		<b>Color</b>	<b>Test Function</b>	<b>Padlockable</b>	<b>Defeatable</b>	<b>Part Number</b>	
		All Switches		Red	N	Y	N	H79-4	
		and ...							
		<b>Auxiliary Contacts</b>							
		<b>Contact Type</b>	<b>Number of Contacts</b>	<b>Continuous Amp Rating</b>	<b>Voltage Rating</b>	<b>Max Number of Aux Contacts per Switch</b>		<b>Part Number</b>	
		NO	1	10A	600Vac	8		BAC05	
		NC	1	10A	600Vac	8		BAC06	
		and ...							
		Accessories		<b>Terminal Shrouds - includes terminal shroud for lineside or loadside</b>					
<b>Switch Amp Rating</b>	<b>Number of Poles</b>						<b>Part Number</b>		
600-800	2						TSH10-2TB		
600-800	3						TSH10-3TB		
600-800	4				TSH10-4TB				



# UL 98 Fused Rotary Disconnect Switches—600 & 800A

Standard Class J & Class L

**Dimensions – in (mm)**

- RDF600J-3 • RDF800L-3

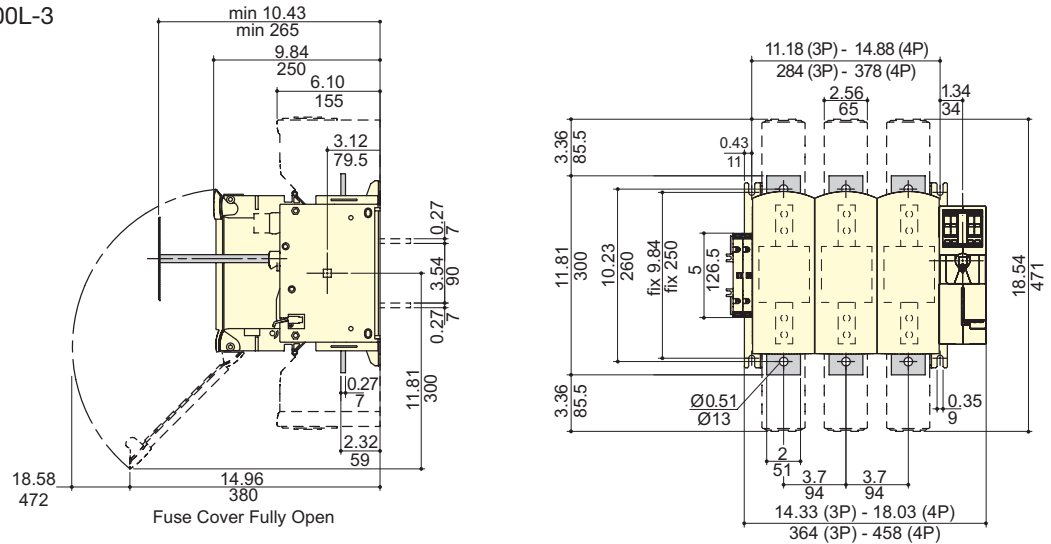

**Direct Mount Handle**

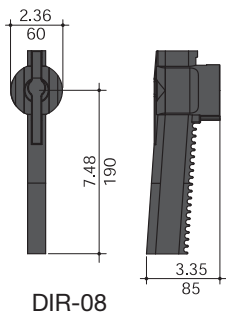

**External Front Pistol Handle**

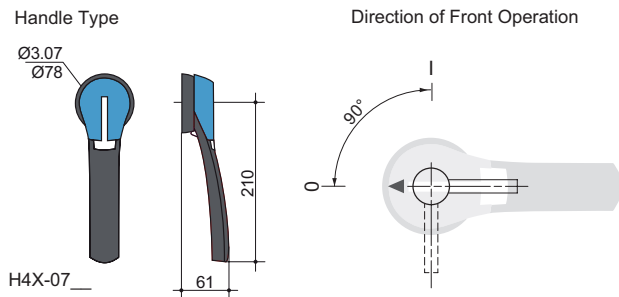

**Terminal Lugs**

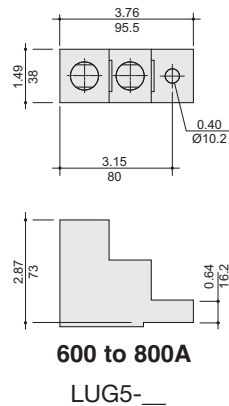

# UL 98 Non-Fused Rotary Disconnect Switches—30 to 1200A

## Description

Bussmann UL 98 non-fused rotary disconnect switches are versatile switches that “break” and “make” power circuits ON and OFF load.

## Features

- Make and break power under load
- Up to 200kA SCCR
- Panel mount (30-100A compact DIN-Rail or panel mount)
- Disconnect switches are front, right side and direct handle operable (30-100A)
- Finger-safe (30-100A compact only)
- Fully visualized breaking (100-1200A)

## Agency Information

- UL98, Guide WHTY, File E155130
- CSA 22.2 No. 4, File 257020
- Conforms with IEC 60947-3

## Online Resources

Visit [www.cooperbussmann.com/Disconnects](http://www.cooperbussmann.com/Disconnects) for:

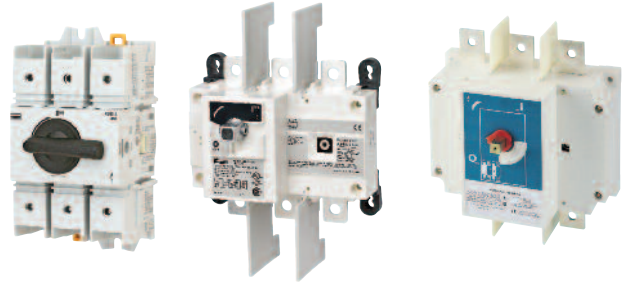

- CAD Drawings
- Instruction Sheets
- UL Information



**QuikShip** Everyday

QuikShip Everyday Service ships the most common part numbers within 24 hours. Contact your Bussmann representative for details.

Related Bussmann Products		Data Sheet #
<b>Fuse Blocks</b>		
Modular Knifeblade Fuse Blocks 100-600A		3192
Class J Power Distribution Fuse Blocks 100-400A		10192
<b>Fuses Holders</b>		
CH Series Class CC, Midget & 10x38 0-30A		3185
Finger-Safe Optima Series 0-30A		1102
Optima™ Protection Modules 0-30A		1109
CH Series Class J 0-60A		2144

IEC Electrical Specifications										
  										
Part Number	RD30-3	RD60-3	RD100-3	RD100-3-SCCR	RD200-3	RD400-3	RD600-3	RD800-3	RD1000-3	RD1200-3
3-Pole	RD30-3	RD60-3	RD100-3	RD100-3-SCCR	RD200-3	RD400-3	RD600-3	RD800-3	RD1000-3	RD1200-3
4-Pole	—	—	—	—	RD200-4	RD400-4	RD600-4	RD800-4	RD1000-4	RD1200-4
Thermal Current $I_{th}$ @ 40°C (A)	30	60	100	100	200	400	—	—	—	—
Rated insulation voltage $U_i$ (V)	800	800	800	1000	1000	1000	1000	1000	1000	1000
Rated impulse withstand voltage $U_{imp}$ (kV)	8	8	8	8	8	8	12	12	12	12
<b>Rated Operation Currents <math>I_b</math> (A)</b>										
Rated Voltage	A <sup>(1)</sup>	A <sup>(1)</sup>	A <sup>(1)</sup>	A <sup>(1)</sup>	A <sup>(1)</sup>	A <sup>(1)</sup>	A <sup>(1)</sup>	A <sup>(1)</sup>	A <sup>(1)</sup>	A <sup>(1)</sup>
Load Duty Category	AC-22 A	AC-23 A	AC-23 A	AC-23 A	AC-23 A	AC-23 A	AC-23 A	AC-23 A	AC-23 A	AC-23 A
400Vac	32	63	100	100	200	400	630	800	1000	1200
400Vac	32	63	100	100	200	400	630	800	1000	1000
690Vac	32	63	80	100	200	400	500	630	630	630
690Vac	32	63	63	100	200	315	200	400	400	400
<b>Operational Power (Vac) in AC-23 (kW)</b>										
400V w/o prebreak AC <sup>(1)(2)</sup>	15	30	45	51	100	220	355	450	560	560
500V w/o prebreak AC <sup>(1)(2)</sup>	15	30	45	63	140	280	450	560	560	560
690V w/o prebreak AC <sup>(1)(2)</sup>	18.5	30	45	90	185	185	185	400	400	400
<b>Overload Capacity (<math>U_e</math> 415Vac)</b>										
Rated short-circuit making capacity $I_{cm}$ (kA peak) <sup>(3)</sup>	12	12	12	17.6	32	48	48	75	48	75
<b>Fuse Protected Short-Circuit Withstand (kA rms prospective)</b>										
Short-Circuit Current (kA) <sup>(3)</sup>	50	50	25	200	200	200	100	100	100	100
Associated Fuse Rating (A) <sup>(3)</sup>	32	63	100	100	200	400	630	800	1000	1250
<b>Connection</b>										
Minimum Cu cable cross section (mm <sup>2</sup> )	2.5	2.5	10	35	70	185	2x150	2x185	2x240	—
Minimum Cu busbar section (mm <sup>2</sup> )	—	—	—	—	—	—	2x30x5	2x40x5	2x50x5	2x60x5
Maximum Cu cable section (mm <sup>2</sup> )	70	70	70	300	300	600	—	—	—	—

(1) A/B: Category with index A = frequent operation; category with index B = infrequent operation.  
 (2) The power value is given for information only; the current values vary from one manufacturer to another.  
 (3) For a rated operating voltage,  $U_e = 400$ Vac.

# UL 98 Non-Fused Rotary Disconnect Switches—30 to 1200A

## UL Electrical Specifications



RD30-3



RD200-3











RD600-3

Part Number	RD30-3	RD60-3	RD100-3	RD100-3-SCCR	RD200-3	RD400-3	RD600-3	RD800-3	RD1000-3	RD1200-3
<b>3-Pole</b>	RD30-3	RD60-3	RD100-3	RD100-3-SCCR	RD200-3	RD400-3	RD600-3	RD800-3	RD1000-3	RD1200-3
<b>4-Pole</b>	—	—	—	—	RD200-4	RD400-4	RD600-4	RD800-4	RD1000-4	RD1200-4
UL Standard	UL 98	UL 98	UL 98	UL 98	UL 98	UL 98	UL 98	UL 98	UL 98	UL 98
Max Ampacity	30A	60A	100A	100A	200A	400A	600A	800A	1000A	1200A
Switch Type	Compact	Compact	Compact	Standard	Standard	Standard	Standard	Standard	Standard	Standard
Handle Operation	Front/Side	Front/Side	Front/Side	Front	Front	Front	Front	Front	Front	Front
<b>UL Electrical Ratings</b>										
Max Voltage (AC)	600Vac	600Vac	600Vac	600Vac	600Vac	600Vac	600Vac	600Vac	600Vac	600Vac
Max Voltage (DC)	—	—	—	250Vdc	250Vdc	—	250Vdc	—	—	—
Maximum AC Horsepower Ratings										
1-Phase, 120Vac	2	3	5	—	—	—	—	—	—	—
1-Phase, 240Vac	5	10	10	10	10	—	—	—	—	—
3-Phase, 240Vac	10	20	20	30	75	125	200	200	200	200
3-Phase, 480Vac	20	40	50	75	150	250	400	500	500	500
3-Phase, 600Vac	25	50	50	100	200	350	350	500	500	500
DC Horsepower Ratings										
125Vdc	—	—	—	—	—	—	20	—	—	—
250Vdc	—	—	—	—	—	—	50	—	—	—
<b>Electrical Characteristics</b>										
SCCR with Fuse	100kA	100kA	25kA/100kA*	200kA	200kA	200kA	200kA	100kA	100kA	100kA
Fuse Class	J	J	J	J	J	J	J	L	L	L
Max. Fuse Rating	30A	60A	100A	100A	200A	400A	600A	800A	1000A	1200A
Terminal Lugs/Kits	Integral	Integral	Integral	•	•	•	•	•	•	•
Lug Mounting Torque - Lb-In (N•m)	-	-	-	160 (18)	160 (18)	LUG2-...310 (35) LUG3-...398 (45)	310 (35)	310 (35)	310 (35)	310 (35)
Wire Type	75°C Cu	75°C Cu	75°C Cu	75°C Cu/Al	75°C Cu/Al	75°C Cu/Al	75°C Cu/Al	75°C Cu/Al	75°C Cu/Al	75°C Cu/Al
Wire Range & Torque - Lb-In (N•m)										
Solid	#12-10 35.4 (4)	#12-10 35.4 (4)	#12-10 35.4 (4)	—	—	—	—	—	—	—
Stranded	#10-1 35.4 (4) 1/0 39.8 (4.5) 2/0 44.3 (5)	#10-1 35.4 (4) 1/0 39.8 (4.5) 2/0 44.3 (5)	#10-1 35.4 (4) 1/0 39.8 (4.5) 2/0 44.3 (5)	#6-300MCM 275 (31)	#6-300MCM 275 (31)	LUG2-...#4-600MCM 550 (62) Dual 1/0-250MCM 550 (62) LUG3-...(2) #6-2 200 (22.6) (2) #1-350MCM 375 (42.4)	(2) #2-600MCM 375 (42.4)	(4) #2-600MCM 375 (42.4)	(4) #2-600MCM 375 (42.4)	(4) #2-600MCM 375 (42.4)
<b>Mechanical Characteristics</b>										
Endurances/Cycles	10,000	10,000	10,000	10,000	8000	6000	6000	3500	3500	3500
<b>Physical Characteristics</b>										
Dimensions	See drawings on product pages									
Weight - Lbs (KG)										
3-Pole	1.3 (0.6)	1.3 (0.6)	1.3 (0.6)	4.2 (1.91)	4.2 (1.91)	10.0 (4.6)	18.1 (8.2)	19.6 (8.9)	19.6 (8.9)	19.6 (8.9)
4-Pole	—	—	—	—	5.0 (2.3)	12.3 (5.6)	23.9 (10.9)	25.3 (11.5)	25.3 (11.5)	25.3 (11.5)
<b>Environmental</b>										
Operating Temperature	-20°C to 70°C	-20°C to 70°C	-20°C to 70°C	-20°C to 70°C	-20°C to 70°C	-20°C to 70°C	-20°C to 70°C	-20°C to 70°C	-20°C to 70°C	-20°C to 70°C
Flammability Rating	UL 94-V0	UL 94-V0	UL 94-V0	UL 94-V0	UL 94-V0	UL 94-V0	UL 94-V0	UL 94-V0	UL 94-V0	UL 94-V0
<b>Accessories</b>										
Lug Kit Part #										
3-Pole	Integral	Integral	Integral	•	•	•	•	•	•	•
4-Pole	—	—	—	—	•	•	•	•	•	•
Handles										
NEMA 1, 3R, 12	•	•	•	•	•	•	—	—	—	—
NEMA 1, 3R, 4, 4X, 12	•	•	•	•	•	•	•	•	•	•
Direct	•	•	•	•	•	•	•	•	•	•
Front Pistol	•	•	•	•	•	•	•	•	•	•
Front or Side Selector	•	•	•	—	—	—	—	—	—	—
Shaft c/s - mm	5x5	5x5	5x5	10x10	10x10	10x10	12x12	12x12	12x12	12x12
Shaft Guide	•	•	•	•	•	•	•	•	•	•
Shrouds	•	•	•	•	•	•	•	•	•	•
Additional Pole Accessory	•	•	•	—	—	—	—	—	—	—
Auxiliary Contacts										
NO + NC	•	•	•	•	•	•	•	•	•	•
(2) NO	•	•	•	•	•	•	•	•	•	•

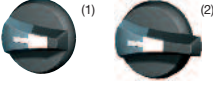

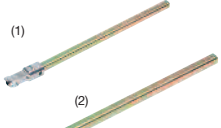
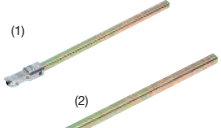
• Available, see product page for details and part numbers.  
 — Not available.  
 \* 25kA @ 600Vac, 100kA @ 480Vac.

# UL 98 Non-Fused Rotary Disconnect Switches—30, 60 and Compact 100A

For a Complete Assembly, Please Select:

SWITCH		<b>Switch</b>										
		Switch Amp Rating	No. of Poles	SCCR	Max Horsepower Rating					Wire Size	Wire Type	Part Number
					1-Phase		3-Phase					
					120 Vac	220/240Vac	220/240Vac	440/480Vac	600 Vac			
	30	3	100kA	2	5	10	20	25	#10-2/0 Str #12-10 Sol	75°C Cu	RD30-3	
	60	3	100kA	3	10	20	40	50	#10-2/0 Str #12-10 Sol	75°C Cu	RD60-3	
	100	3	25/100kA*	5	10	20	50	50	#10-2/0 Str #12-10 Sol	75°C Cu	RD100-3	
	* 100kA @480Vac, 25kA @ 600Vac.											
	+											
	HANDLES		<b>Direct Mount Handle - mounts directly to switch, no shaft required</b>									
For Switch Part Number			Color		Test Function	Padlockable				Part Number		
All Switches		Black		N	Y - On Switch				DIR-02			
OR												
		<b>External Front or Right Side Operated Selector Handles - shaft required</b>										
		NEMA Type	Color	Handle Length	Test Function	Padlockable				Part Number		
1, 3R, 4, 4X, 12		Black	Short	N	Y				H4X-01B <sup>(1)</sup>			
1, 3R, 4, 4X, 12		Red/Yellow	Short	N	Y				H4X-01R <sup>(1)</sup>			
1, 3R, 4, 4X, 12		Black	Long	N	Y				H4X-02B <sup>(2)</sup>			
1, 3R, 4, 4X, 12		Red/Yellow	Long	N	Y				H4X-02R <sup>(2)</sup>			
	<b>External Front Operated Pistol Handles - shaft required</b>											
	NEMA Type	Color	Handle Length	Test Function	Padlockable	Defeatable			Part Number			
1, 3R, 4, 4X, 12	Black	—	N	Y	Y			H4X-03B				
1, 3R, 4, 4X, 12	Red/Yellow	—	N	Y	Y			H4X-03R				
	<b>Metallic Hasp (Heavy Duty) External Front Operated Pistol Handles - shaft required</b>											
	NEMA Type	Color	Handle Length	Test Function	Padlockable	Defeatable			Part Number			
1, 3R, 4, 4X, 12	Black	—	N	Y	Y			H4X-03BHD				
1, 3R, 4, 4X, 12	Red/Yellow	—	N	Y	Y			H4X-03RHD				
	<b>Shafts for Selector Handles</b>											
	Length in (mm)	Mounting Depth (X) in (mm)							Part Number			
	5.9 (150)	3.50~7.60 (89~193)							SH4-150 <sup>(1)</sup>			
	7.9 (200)	3.50~9.50 (89~241)							SH4-200 <sup>(1)</sup>			
12.6 (320)	3.50~14.9 (89~378)							SH4-320 <sup>(1)</sup>				
	<b>Shafts for Pistol Handles</b>											
	Length in (mm)	Mounting Depth (X) in (mm)							Part Number			
	7.9 (200)	3.30~7.40 (84~188)							SH3-200 <sup>(2)</sup>			
	12.6 (320)	3.30~9.30 (84~236)							SH3-320 <sup>(2)</sup>			
15.7 (400)	3.30~14.7 (84~373)							SH3-400 <sup>(2)</sup>				
	<b>Shaft Guide for Selector Handles</b>											
									Part Number			
									SH-GUIDE1			
	<b>Shaft Guide for Pistol Handles</b>											
									Part Number			
									SH-GUIDE2			
and ...												
Acc's AUX CONTACTS		<b>Auxiliary Contacts</b>										
		Contact Type	Number of Contacts	Continuous Amp Rating	Voltage Rating	Max Number of Units per Switch				Part Number		
		NO + NC	1 of each	10A	240Vac	2 (1 per side/4 contacts total)				BAC01		
									BAC02			

# UL 98 Non-Fused Rotary Disconnect Switches—30, 60 and Compact 100A

		and ...				
<b>Accessories</b>	SHROUDS		<b>Terminal Shrouds</b> - includes terminal shroud for both lineside and loadside			
			<b>Switch Amp Rating</b>	<b>Number of Poles</b>	<b>Location on Switch</b>	<b>Part Number</b>
			All Switches	1 (for switched 4 <sup>th</sup> pole)	Lineside and Loadside	TSH3-1TB
		All Switches	3	Lineside and Loadside	TSH3-3TB	
		and ...				
<b>Accessories</b>	SW. 4 <sup>TH</sup> POLE		<b>Switched 4<sup>th</sup> Pole</b> - converts 3-pole switch to 4-pole			
			<b>Switch Amp Rating</b>			<b>Part Number</b>
			30			POLE98-30
			60			POLE98-60
		100			POLE98-100	



Auxiliary Contact Configurations

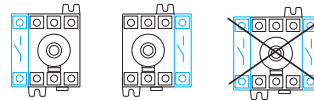

Possible 4<sup>th</sup> Pole Configurations

## Dimensions - in (mm)

### Direct Handle Operation

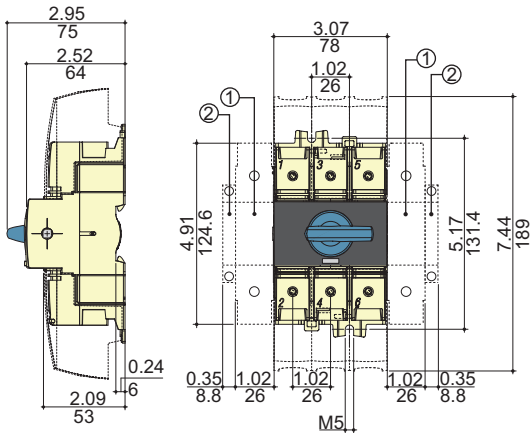

### External Front Operation

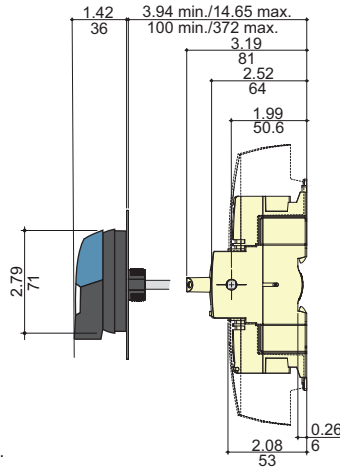

### External Right Side Operation

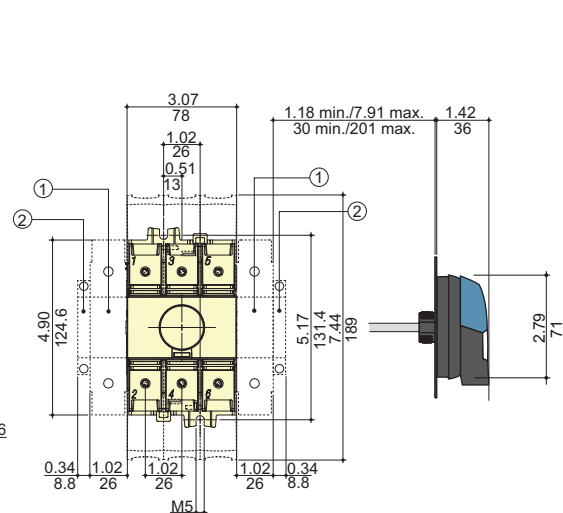

1. Position for 1 switched 4<sup>th</sup> pole (1 per device max.) or 1 auxiliary contact.
  2. Position for 1 auxiliary contact only.
- Note: Maximum of 4 auxiliary contacts, or 3 auxiliary contacts + one switched 4<sup>th</sup> pole.

## External Front/Right Side Operated Selector Handle, Front Operated Pistol Handle

Handle Type

Door Drilling Layouts

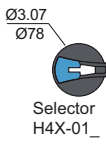

Selector H4X-01\_

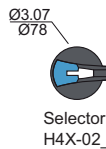

Selector H4X-02\_

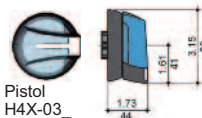

Pistol H4X-03\_

Direction of Front Operation

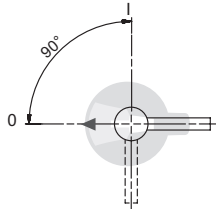

Direction of Right Side Operation

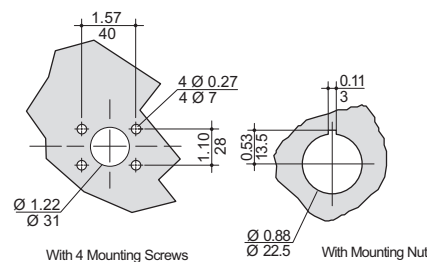
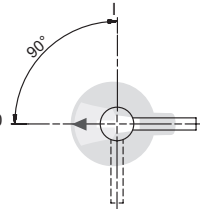

With 4 Mounting Screws

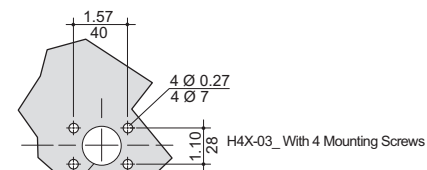



H4X-03\_ With 4 Mounting Screws

Ø 1.45in/37mm Screw clip (from front)  
Ø 1.22in/31mm Screw (from rear)

## UL 98 Non-Fused Rotary Disconnect Switches— 100, 200 and 400A

For a Complete Assembly, Please Select:

Select for Standard Applications		<b>Switch</b>							
		Switch Amp Rating	No. of Poles	SCCR	Max Horsepower Rating				Part Number
					1-Phase 220/240Vac	220/240Vac	3-Phase 440/480Vac	600 Vac	
		100	3	200kA	10	30	75	100	RD100-3-SCCR
		200	3	200kA	10	75	150	200	RD200-3
		200	4	200kA	10	75	150	200	RD200-4
		400	3	200kA	-	125	250	350	RD400-3
		400	4	200kA	-	125	250	350	RD400-4
		<b>Terminal Lug Kit</b>							
		Switch Amp Rating	No. of Poles	Lugs Per Kit	Wire Range		Wire Type	Part Number	
		100-200	2	2	#6-300MCM		75°C Cu/Al	LUG1-2	
		100-200	3	3	#6-300MCM		75°C Cu/Al	LUG1-3	
		100-200	4	4	#6-300MCM		75°C Cu/Al	LUG1-4	
400	2	2	#4-600MCM or Dual 1/0-250MCM		75°C Cu/Al	LUG2-2			
400	3	3	#4-600MCM or Dual 1/0-250MCM		75°C Cu/Al	LUG2-3			
400	4	4	#4-600MCM or Dual 1/0-250MCM		75°C Cu/Al	LUG2-4			
400	2	2	(2) #6-350MCM		75°C Cu/Al	LUG3-2			
400	3	3	(2) #6-350MCM		75°C Cu/Al	LUG3-3			
400	4	4	(2) #6-350MCM		75°C Cu/Al	LUG3-4			
Accessories		<b>Direct Mount Handle - mounts directly to switch, no shaft required</b>							
		For Switch Part Number	Color	Test Function	Padlockable			Part Number	
		All Switches	Black	N	Y			DIR-03	
		OR							
		<b>External Front Operated Pistol Handles - shaft required</b>							
		NEMA Type	Color	Test Function	Padlockable	Defeatable	Part Number		
		1, 3R, 12	Black	N	Y	Y	H12-03B		
		1, 3R, 12	Red/Yellow	N	Y	Y	H12-03R		
		1, 3R, 4, 4X, 12	Black	N	Y	Y	H4X-06B		
		1, 3R, 4, 4X, 12	Red/Yellow	N	Y	Y	H4X-06R		
		<b>Metallic Hasp (Heavy Duty) External Front Operated Pistol Handles - shaft required</b>							
		NEMA Type	Color	Test Function	Padlockable	Defeatable	Part Number		
		1, 3R, 4, 4X, 12	Black	N	Y	Y	H4X-06BHD		
1, 3R, 4, 4X, 12	Red/Yellow	N	Y	Y	H4X-06RHD				
<b>Shafts for Pistol Handles</b>									
Length in (mm)	Mounting Depth (X) in (mm)					Part Number			
7.9 (200)	5.31~10.43 (135~265)					SH5-200			
12.6 (320)	5.31~15.16 (135~385)					SH5-320			
15.7 (400)	5.31~18.31 (135~465)					SH5-400			
<b>Shaft Guide</b>							Part Number		
Required for 15.7" (400mm) long shafts, optional for other lengths						SH-GUIDE2			
and ...									
<b>Auxiliary Contacts</b>									
Contact Type	Number of Contacts	Continuous Amp Rating	Voltage Rating	Max Number of Aux Contacts per Switch	Part Number				
NO + NC	1 of each	10.1A	125-250Vac	2	BAC03*				
NO + NC	1 of each	10.1A	125-250Vac	2	BAC04*				
NO + NC	1 of each	1A	125Vac	2	BAC11*				
NO + NC	1 of each	1A	125Vac	2	BAC12*				
* For one auxiliary contact, install either BAC03 or BAC11. For two auxiliary contacts, install BAC03 + BAC04, or BAC11 + BAC12.									

UL 98 Non-Fused Rotary Disconnect Switches—100, 200 and 400A

and ...

Accessories	SHROUDS	Terminal Shrouds - includes terminal shroud for lineside or loadside			
		Switch Amp Rating	Number of Poles	Location on Switch	Part Number
		100-200A	3	Lineside	TSH4-3T
		100-200A	3	Loadside	TSH4-3B
		100-200A	4	Lineside or Loadside	TSH4-4TB
		400A	3	Lineside	TSH5-3T
		400A	3	Loadside	TSH5-3B
		400A	4	Lineside or Loadside	TSH5-4TB

Dimensions - in (mm)

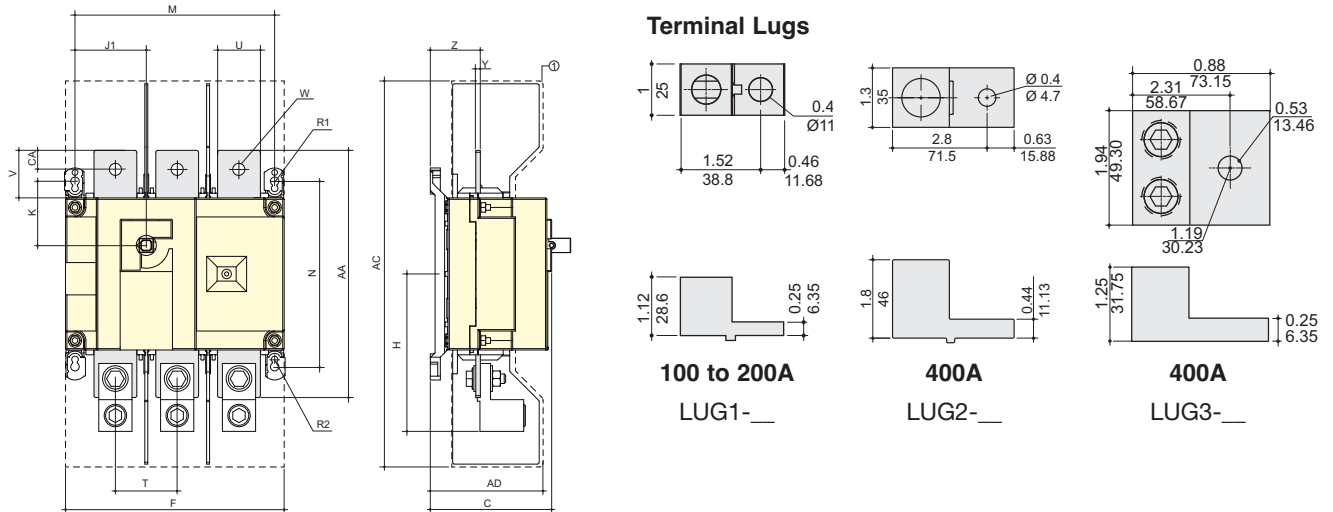

Switch Rating (A)	Overall Dimen. C	Terminal Shrouds		Switch Body						Switch Mounting				Connection								
		AC	AD	F 3p.	F 4p.	H	J1 3p.	J1 4p.	K	M 3p.	M 4p.	N	R1	R2	T	U	V	W	Y	Z	AA	AC
100	3.72 (94.6)	10.1 (256)	3.05 (77.5)	7.09 (180)	9.06 (230)	4.22 (107)	2.17 (55)	4.13 (105)	1.8 (45.6)	6.3 (160)	8.27 (210)	5.31 (135)	0.35 (9)	0.27 (7)	1.97 (50)	0.98 (25)	1.18 (30)	0.43 (11)	0.14 (3.5)	1.35 (34.4)	6.3 (160)	0.6 (15)
200	3.72 (94.6)	10.1 (256)	3.05 (77.5)	7.09 (180)	9.06 (230)	4.22 (107)	2.17 (55)	4.13 (105)	1.8 (45.6)	6.3 (160)	8.27 (210)	5.31 (135)	0.35 (9)	0.27 (7)	1.97 (50)	0.98 (25)	1.18 (30)	0.43 (11)	0.14 (3.5)	1.35 (34.4)	6.3 (160)	0.6 (15)
400	4.92 (128)	16 (406)	4.15 (115)	9.05 (230)	11.4 (290)	6.53 (166)	2.95 (75)	5.31 (135)	2.65 (67.5)	8.26 (210)	10.6 (270)	7.67 (195)	0.35 (9)	0.27 (7)	2.56 (65)	1.77 (45)	1.97 (50)	0.43 (13)	0.2 (5)	2.08 (53)	10.2 (260)	0.8 (20)

Direct Mount Handle

External Front Handle

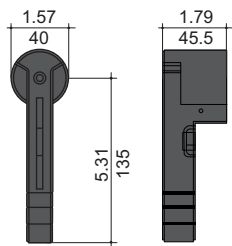

DIR-03

Handle Type



H4X-06  
H12-03

Direction of Front Operation

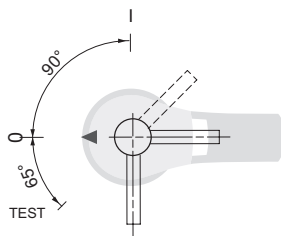

Door Drilling Layout

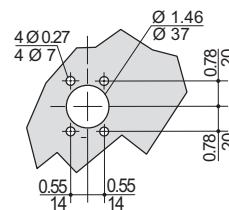

# UL 98 Non-Fused Rotary Disconnect Switches—600, 800, 1000 and 1200A

For a Complete Assembly, Please Select:

SWITCH + LUGS		<b>Switch</b>							<b>Part Number</b>			
		<b>Switch Amp Rating</b>	<b>No. of Poles</b>	<b>SCCR</b>	<b>Max Horsepower Rating</b>							
					<b>3-Phase</b>			<b>DC*</b>				
					<b>220/240Vac</b>	<b>440/480Vac</b>	<b>600 Vac</b>	<b>125 Vdc</b>		<b>250 Vdc</b>		
		600A	3	200kA	240	400	350	20		50		
		600A	4	200kA	240	400	350	20		50		
		800A	3	100kA	200	500	500	-		-		
		800A	4	100kA	200	500	500	-		-		
		1000A	3	100kA	200	500	500	-		-		
		1000A	4	100kA	200	500	500	-		-		
1200A	3	100kA	200	500	500	-	-					
1200A	4	100kA	200	500	500	-	-					
* DC Ratings use two poles in series.												
SELECT FOR STANDARD APPLICATIONS		<b>Terminal Lug Kit</b>							<b>Part Number</b>			
		<b>Switch Amp Rating</b>	<b>No. of Poles</b>	<b>Lugs Per Kit</b>	<b>Lugs Required per Pole</b>	<b>Wire Range</b>	<b>Wire Type</b>					
		600	3	3	1	(2) #2-600MCM	75°C Cu/Al					
		600	4	4	1	(2) #2-600MCM	75°C Cu/Al					
		800-1200	3	6	2	(4) #2-600MCM	75°C Cu/Al					
		800-1200	4	8	2	(4) #2-600MCM	75°C Cu/Al					
		+										
		HANDLE		<b>Direct Mount Handle - mounts directly to switch, no shaft required</b>							<b>Part Number</b>	
				<b>For Switch Part Number</b>	<b>Color</b>	<b>Test Function</b>	<b>Padlockable</b>					
All Switches	Black	N	Y	DIR-04								
or												
HANDLE		<b>External Front Operated Pistol Handles - shaft required</b>							<b>Part Number</b>			
		<b>NEMA Type</b>	<b>Color</b>	<b>Test Function</b>	<b>Padlockable</b>	<b>Defeatable</b>						
		1, 3R, 4, 4X, 12	Black	N	Y	Y						
		1, 3R, 4, 4X, 12	Red/Yellow	N	Y	Y						
		1, 3R, 4, 4X, 12	Black	N	Y	Y						
		1, 3R, 4, 4X, 12	Red/Yellow	N	Y	Y						
		<b>Metallic Hasp (Heavy Duty) External Front Operated Pistol Handles - shaft required</b>										
		<b>NEMA Type</b>	<b>Color</b>	<b>Test Function</b>	<b>Padlockable</b>	<b>Defeatable</b>						
		1, 3R, 4, 4X, 12	Black	N	Y	Y						
		1, 3R, 4, 4X, 12	Red/Yellow	N	Y	Y						
1, 3R, 4, 4X, 12	Black	N	Y	Y								
1, 3R, 4, 4X, 12	Red/Yellow	N	Y	Y								
<b>Shafts for Pistol Handles</b>												
<b>Length in (mm)</b>	<b>Mounting Depth (X) in (mm)</b>		<b>Part Number</b>									
7.9 (200)	8.70~13.50 (221~343)		SH6-200									
12.6 (320)	8.70~18.23 (221~463)		SH6-320									
15.7 (400)	8.70~21.38 (221~543)		SH6-400									
<b>Shaft Guide</b>							<b>Part Number</b>					
Required for 15.7" (400mm) long shafts, optional for other lengths												
and ...												
ACCESSORIES		<b>Auxiliary Contacts</b>										
		<b>Contact Type</b>	<b>Number of Contacts</b>	<b>Continuous Amp Rating</b>	<b>Voltage Rating</b>	<b>Max Number of Aux Contacts per Switch</b>	<b>Part Number</b>					
		NO + NC	1 of each	10.1A	125-250Vac	2	BAC03*					
		NO + NC	1 of each	10.1A	125-250Vac	2	BAC04*					
		NO + NC	1 of each	1A	125Vac	2	BAC11*					
		NO + NC	1 of each	1A	125Vac	2	BAC12*					
* For one auxiliary contact, install either BAC03 or BAC11. For two auxiliary contacts, install BAC03 + BAC04, or BAC11 + BAC12.												



UL 98 Non-Fused Rotary Disconnect Switches—600, 800, 1000 and 1200A

and ...

Accessories	SHROUDS	Terminal Shrouds* - includes terminal shroud for lineside or loadside			
		Switch Amp Rating	Number of Poles	Location on Switch	Part Number
		600A	3	Lineside or Loadside	TSH6-3TB
		600A	4	Lineside or Loadside	TSH6-4TB
		800-1200A	3	Lineside or Loadside	TSH7-3TB
		800-1200A	4	Lineside or Loadside	TSH7-4TB

\* Shroud for lineside included with switch.

Dimensions - in (mm) 600A

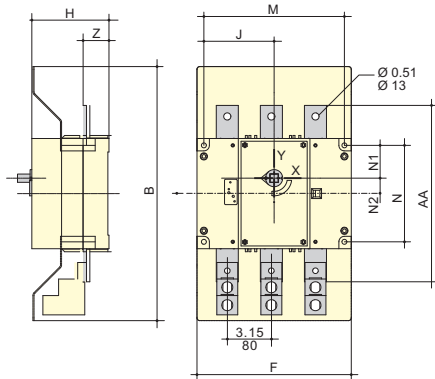

800 to 1200A

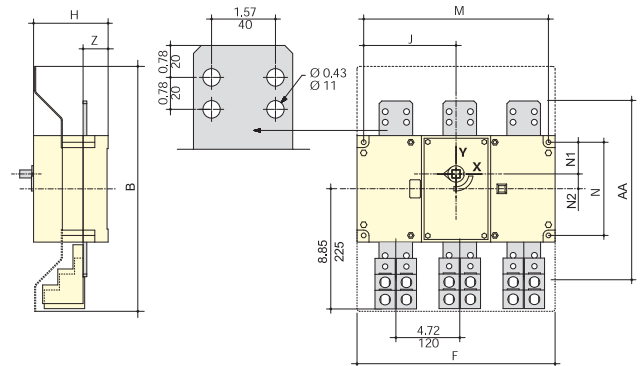

Switch Rating (A)	Terminal Shrouds B	Switch Body				Switch Mounting						Connection	
		F 3p.	F 4p.	H	J 3p.	J 4p.	M 3p.	M 4p.	N	N1	N2	AA	Z
600	18.12 (460)	11 (280)	14.17 (360)	5.5 (140)	5 (127.5)	6.59 (167.5)	10.03 (255)	13.19 (335)	6.88 (175)	2.34 (59.5)	1.10 (28)	12.6 (320)	1.85 (47)
800	18.12 (460)	14.64 (372)	19.37 (492)	5.5 (140)	6.83 (173.5)	9.19 (233.5)	13.66 (347)	18.38 (467)	6.88 (175)	2.34 (59.5)	1.10 (28)	13 (330)	1.85 (47)
1000	18.12 (460)	14.64 (372)	19.37 (492)	5.5 (140)	6.83 (173.5)	9.19 (233.5)	13.66 (347)	18.38 (467)	6.88 (175)	2.34 (59.5)	1.10 (28)	13 (330)	1.85 (47)
1200	18.12 (460)	14.64 (372)	19.37 (492)	5.5 (140)	6.83 (173.5)	9.19 (233.5)	13.66 (347)	18.38 (467)	6.88 (175)	2.34 (59.5)	1.10 (28)	13 (330)	1.85 (47)

External Front Pistol Handles

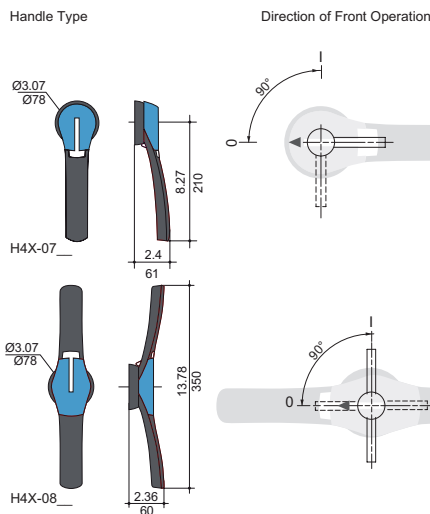

Direct Mount Handle

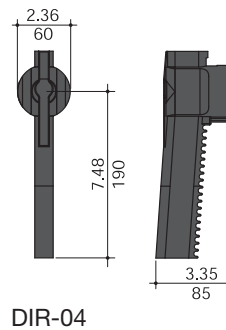

Terminal Lugs

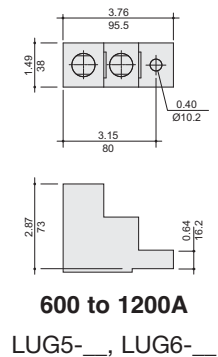

# UL 508 Non-Fused Rotary Disconnect Switches— 16 to 80A

## Description

Bussmann UL 508 load break disconnect switches allow safe control and safe disconnection of any motor application or to isolate a circuit within the panel.

These disconnect switches are compact and offer a wide variety of accessories like 4<sup>th</sup> poles, auxiliary contacts, door mounting and 6/8-Pole kits.

## Features

- Suitable as motor disconnect
- DIN-Rail or panel mount
- Door mount option
- Disconnect switches are front, right side or direct handle operable
- Finger-safe

## Agency Information

- UL508, Guide NLRV, File E155129
- CSA C22.2 No. 14, File 257020
- Conforms with IEC 60947-3

## Online Resources

Visit [www.cooperbussmann.com/Disconnects](http://www.cooperbussmann.com/Disconnects) for:

- CAD Drawings
- Instruction Sheets
- UL Information



Everyday

QuikShip Everyday Service ships the most common part numbers within 24 hours. Contact your Bussmann representative for details.

### Related Bussmann Products

Fuse Blocks	Data Sheet #
Modular Knifeblade Fuse Blocks 100-600A	3192
Class J Power Distribution Fuse Blocks 100-400A	10192
Fuses Holders	
CH Series Class CC, Midget & 10x38 0-30A	3185
Finger-Safe Optima Series 0-30A	1102
Optima™ Protection Modules 0-30A	1109
CH Series Class J 0-60A	2144

## IEC Electrical Specifications

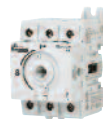

RD16-3-508



RD16-3-508 with 6-Pole Conversion Kit

Part Number	RD16-3-508	RD25-3-508	RD40-3-508	RD63-3-508	RD80-3-508
Thermal Current $I_{th}$ at 40°C (A)	16	25	40	63	80
Rated insulation voltage $U_i$ (V)	800	800	800	800	800
Rated impulse withstand voltage $U_{imp}$ (kV)	8	8	8	8	8
<b>Rated Operation Currents <math>I_n</math> (A)</b>					
Load Duty Category	A/B <sup>(1)</sup>	A/B <sup>(1)</sup>	A/B <sup>(1)</sup>	A/B <sup>(1)</sup>	A/B <sup>(1)</sup>
Rated Voltage					
500Vac AC-22 A/AC-22 B	16/16	25/25	40/40	63/63	80/80
500Vac AC-23 A/AC-23 B	16/16	25/25	25/25	63/63	63/63
690Vac AC-21 A/AC-21 B	16/16	25/25	40/40	63/63	80/80
690Vac AC-22 A/AC-22 B	16/16	25/25	32/40	40/63	63/80
690Vac AC-23 A/AC-23 B	16/16	25/25	25/25	40/40	40/40
<b>Operational Power in AC-23 (kW)</b>					
400Vac without prebreak AC <sup>(1)(2)</sup>	7.5	11	18.5	30	37
500Vac without prebreak AC <sup>(1)(2)</sup>	7.5	11	15	30	37
690Vac without prebreak AC <sup>(1)(2)</sup>	7.5	15	18.5	30	37
<b>Overload Capacity (<math>U_n</math> 415 Vac)</b>					
Rated short-time withstand current 0.3 s. $I_{cw}$ (kA rms) <sup>(3)</sup>	2.5	2.5	2.5	3	3
Rated short-time making capacity $I_{cm}$ (kA peak) <sup>(3)</sup>	6	6	6	9	9
<b>Fuse Protected Short-Circuit Withstand (kA rms Prospective)</b>					
Prospective short-circuit current (kA rms) <sup>(3)</sup>	50	50	50	50	50
Associated fuse rating (A) <sup>(3)</sup>	16	25	40	63	80
<b>Connection</b>					
Minimum Cu cable cross section (mm <sup>2</sup> )	1.5	1.5	1.5	2.5	2.5
Maximum Cu cable section (mm <sup>2</sup> )	16	16	16	35	35
Tightening torque min/max (N·m)	2/2.2	2/2.2	2/2.2	3.5/3.85	3.5/3.85

(1) A/B: Category with index A = frequent operation; category with index B = infrequent operation.

(2) The power value is given for information only; the current values vary from one manufacturer to another.

(3) For a rated operating voltage,  $U_n = 400$ Vac.

# UL 508 Non-Fused Rotary Disconnect Switches— 16 to 80A

## UL Electrical Specifications



RD16-3-508









RD16-3-508 with 6-Pole Conversion Kit

Part Number	RD16-3-508	RD25-3-508	RD40-3-508	RD63-3-508	RD80-3-508
UL Standard	UL 508	UL 508	UL 508	UL 508	UL 508
Max Ampacity	16A	25A	40A	63A	80A
Handle Operation	Front/Side	Front/Side	Front/Side	Front/Side	Front/Side
<b>UL Electrical Ratings</b>					
Max Voltage (AC)	600Vac	600Vac	600Vac	600Vac	600Vac
Maximum Horsepower Ratings					
3-Phase, 208Vac	3	7.5	7.5	15	15
3-Phase, 240Vac	5	7.5	7.5	20	20
3-Phase, 480Vac	10	15	20	40	40
3-Phase, 600Vac	10	20	25	40	40
<b>Electrical Characteristics</b>					
SCCR with Fuse	65kA	65kA	10/65kA	50/65kA	50/65kA
Recommended Upstream					
Fuse Class	J	J	J	J	J
Max. Fuse Rating	30A	30A	60/30A	100/60A	100/60A
Terminals	Integral	Integral	Integral	Integral	Integral
Wire Type	75°C Cu	75°C Cu	75°C Cu	75°C Cu	75°C Cu
Wire Range & Torque - Lb-In (N•m)					
Solid					
Single	#14-10 26.5 (3)	#14-10 26.5 (3)	#14-10 26.5 (3)	#14-10 31.1 (3.5)	#14-10 31.1 (3.5)
Dual	#12 26.5 (3)	#12 26.5 (3)	#12 26.5 (3)	#12 31.1 (3.5)	#12 31.1 (3.5)
Stranded					
Single	#14-4 26.5 (3)	#14-4 26.5 (3)	#14-4 26.5 (3)	#14-1 31.1 (3.5)	#14-1 31.1 (3.5)
Dual	#14-12 26.5 (3)	#14-12 26.5 (3)	#14-12 26.5 (3)	#10-6 31.1 (3.5)	#10-6 31.1 (3.5)
<b>Mechanical Characteristics</b>					
Endurances/Cycles	10,000	10,000	10,000	10,000	10,000
<b>Physical Characteristics</b>					
Dimensions - See drawings on product pages					
Weight - Lb (KG)	0.5 (0.2)	0.5 (0.2)	0.5 (0.2)	0.7 (0.32)	0.7 (0.32)
<b>Environmental</b>					
Operating Temperature	-20°C to 70°C	-20°C to 70°C	-20°C to 70°C	-20°C to 70°C	-20°C to 70°C
Flammability Rating	UL 94-V0	UL 94-V0	UL 94-V0	UL 94-V0	UL 94-V0
<b>Accessories</b>					
Handles					
Direct	DIR-01	DIR-01	DIR-01	DIR-01	DIR-01
Short Selector/NEMA 1, 3R, 4, 4X, 12	H4X-01B H4X-01R	H4X-01B H4X-01R	H4X-01B H4X-01R	H4X-01B H4X-01R	H4X-01B H4X-01R
Long Selector/NEMA 1, 3R, 4, 4X, 12	H4X-02B	H4X-02B	H4X-02B	H4X-02B	H4X-02B
Pistol Handle/NEMA 1, 3R, 4, 4X, 12	H4X-02R H4X-03B H4X-03R	H4X-02R H4X-03B H4X-03R	H4X-02R H4X-03B H4X-03R	H4X-02R H4X-03B H4X-03R	H4X-02R H4X-03B H4X-03R
Metallic Hasp (HD) Pistol Handle/NEMA 1, 3R, 4, 4X, 12	H4X-03BHD H4X-03RHD	H4X-03BHD H4X-03RHD	H4X-03BHD H4X-03RHD	H4X-03BHD H4X-03RHD	H4X-03BHD H4X-03RHD
Selector Handle Shafts - 5x5mm					
5.9"/150mm	SH4-150	SH4-150	SH4-150	SH4-150	SH4-150
7.9"/200mm	SH4-200	SH4-200	SH4-200	SH4-200	SH4-200
12.6"/320mm	SH4-320	SH4-320	SH4-320	SH4-320	SH4-320
Pistol Handle Shafts - 5x5mm					
7.9"/200mm	SH3-200	SH3-200	SH3-200	SH3-200	SH3-200
12.6"/320mm	SH3-320	SH3-320	SH3-320	SH3-320	SH3-320
15.75"/400mm	SH3-400	SH3-400	SH3-400	SH3-400	SH3-400
Selector Handle Shaft Guide	SH-GUIDE1	SH-GUIDE1	SH-GUIDE1	SH-GUIDE1	SH-GUIDE1
Pistol Handle Shaft Guide	SH-GUIDE2	SH-GUIDE2	SH-GUIDE2	SH-GUIDE2	SH-GUIDE2
Door Mount Kit	DOOR-508	DOOR-508	DOOR-508	DOOR-508	DOOR-508
Shrouds/Switch Amps					
1-Pole	TSH1-1TB	TSH1-1TB	TSH1-1TB	TSH2-3TB	TSH2-3TB
3-Pole (Loadside and Lineside)	TSH1-3TB	TSH1-3TB	TSH1-3TB	—	—
Switched 4 <sup>th</sup> Pole/Switch Amps	POLE-16	POLE-25	POLE-40	—	—
Ground Module (Conforms to IEC 60947-3)	GND-16-40	GND-16-40	GND-16-40	GND-63-80	GND-63-80
Neutral Module (Conforms to IEC 60947-3)	NTRL-16-40	NTRL-16-40	NTRL-16-40	NTRL-63-80	NTRL-63-80
Auxiliary Contacts					
NO + NC (1 ea.)	BAC01	BAC01	BAC01	BAC01	BAC01
(2) NO	BAC02	BAC02	BAC02	BAC02	BAC02
AC Ratings					
Volts	240Vac	240Vac	240Vac	240Vac	240Vac
Amps	10A	10A	10A	10A	10A
6-/8-Pole Conversion Kit					
Gangs two switches of same rating, 16-80A switch amps	KIT-6POLE	KIT-6POLE	KIT-6POLE	KIT-6POLE	KIT-6POLE
— Not available.					

# UL 508 Non-Fused Rotary Disconnect Switches— 16, 25, 40, 63 and 80A

For a Complete Assembly, Please Select:

SWITCH	<b>Switch</b>										
	Switch Amp Rating	No. of Poles	SCCR @600V	Max Class J Fuse	Max Horsepower Rating, 3-Ph				Wire Size	Wire Type	Part Number
					208 Vac	220/240Vac	440/480Vac	600 Vac			
	16	3	65kA	30A	3	5	10	10	#14-#10 Sol Dual #12 Sol #14-#4 Str Dual #14-#12 Str	75°C Cu	RD16-3-508
	25	3	65kA	30A	7.5	7.5	15	20	#14-#10 Sol Dual #12 Sol #14-#4 Str Dual #14-#12 Str	75°C Cu	RD25-3-508
	40	3	10kA 65kA	60A 30A	7.5	7.5	20	25	#14-#10 Sol Dual #12 Sol #14-#4 Str Dual #14-#12 Str	75°C Cu	RD40-3-508
63	3	50kA 65kA	100A 60A	15	20	40	40	#14-#10 Sol Dual #12 Sol #14-#1 Str Dual #10-#6 Str	75°C Cu	RD63-3-508	
80	3	50kA 65kA	100A 60A	15	20	40	40	#14-#10 Sol Dual #12 Sol #14-#1 Str Dual #10-#6 Str	75°C Cu	RD80-3-508	
+											
SELECT FOR STANDARD APPLICATIONS	<b>Direct Mount Handle - mounts directly to switch, no shaft required</b>										
			<b>For Switch Part Number</b>		<b>Color</b>		<b>Test Function</b>		<b>Padlockable</b>		<b>Part Number</b>
			All Switches		Black		N		Y - On Switch		DIR-01
	OR										
	<b>External Front or Right Side Operated Selector Handles - shaft required</b>										
	 (1)  (2)		<b>NEMA Type</b>	<b>Color</b>	<b>Handle Length</b>	<b>Test Function</b>	<b>Padlockable</b>	<b>Part Number</b>			
			1, 3R, 4, 4X, 12	Black	Short	N	Y	H4X-01B <sup>(1)</sup>			
			1, 3R, 4, 4X, 12	Red/Yellow	Short	N	Y	H4X-01R <sup>(1)</sup>			
			1, 3R, 4, 4X, 12	Black	Long	N	Y	H4X-02B <sup>(2)</sup>			
			1, 3R, 4, 4X, 12	Red/Yellow	Long	N	Y	H4X-02R <sup>(2)</sup>			
<b>External Front Operated Pistol Handles - shaft required</b>											
		<b>NEMA Type</b>	<b>Color</b>	<b>Handle Length</b>	<b>Test Function</b>	<b>Padlockable</b>	<b>Defeatable</b>	<b>Part Number</b>			
		1, 3R, 4, 4X, 12	Black	—	N	Y	Y	H4X-03B			
		1, 3R, 4, 4X, 12	Red/Yellow	—	N	Y	Y	H4X-03R			
<b>Metallic Hasp (Heavy Duty) External Front Operated Pistol Handles - shaft required</b>											
		<b>NEMA Type</b>	<b>Color</b>	<b>Handle Length</b>	<b>Test Function</b>	<b>Padlockable</b>	<b>Defeatable</b>	<b>Part Number</b>			
		1, 3R, 4, 4X, 12	Black	—	N	Y	Y	H4X-03BHD			
		1, 3R, 4, 4X, 12	Red/Yellow	—	N	Y	Y	H4X-03RHD			
<b>Shafts for Selector Handles</b>											
 (1)  (2)		<b>Length in (mm)</b>	<b>Mounting Depth (X) in (mm)</b>					<b>Part Number</b>			
		5.9 (150)	3.50-7.60 (89-193)					SH4-150 <sup>(1)</sup>			
		7.9 (200)	3.50-9.50 (89-241)					SH4-200 <sup>(1)</sup>			
		12.6 (320)	3.50-14.9 (89-378)					SH4-320 <sup>(1)</sup>			
<b>Shafts for Pistol Handles</b>											
 (1)  (2)		<b>Length in (mm)</b>	<b>Mounting Depth (X) in (mm)</b>					<b>Part Number</b>			
		7.9 (200)	3.30-7.40 (84-188)					SH3-200 <sup>(2)</sup>			
		12.6 (320)	3.30-9.30 (84-236)					SH3-320 <sup>(2)</sup>			
		15.7 (400)	3.30-14.7 (84-373)					SH3-400 <sup>(2)</sup>			
<b>Shaft Guides for Selector and Pistol Handles</b>											
		<b>Handle Type</b>								<b>Part Number</b>	
		Selector	Required for 12.6" (320mm) long shafts, optional for other lengths							SH-GUIDE1	
		Pistol	Required for 15.7" (400mm) long shafts, optional for other lengths							SH-GUIDE2	
<b>Door Mount Kit - for mounting switch on the right side of the enclosure or directly on the enclosure door using switch side operation shaft location. Kit includes a shaft. <i>Order switch and selector handle separately.</i></b>											
		<b>Switch Rating</b>								<b>Part Number</b>	
		All Switches - kit includes shaft								DOOR-508	



# UL 508 Non-Fused Rotary Disconnect Switches—16, 25, 40, 63 and 80A

## Dimensions – in (mm)

### Direct Front Operation for 6/8-Pole Disconnects

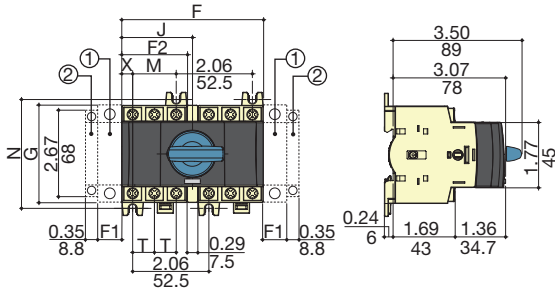

### External Front Operation for 6/8-Pole Disconnects

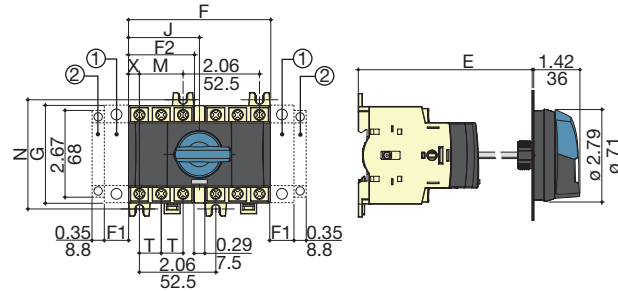

- 1. Position for 1 switched 4<sup>th</sup> pole (1 per device max.) or 1 auxiliary contact.
  - 2. Position for 1 auxiliary contact only.
- Note: Maximum of 4 auxiliary contacts, or 3 auxiliary contacts + one switched 4<sup>th</sup> pole.

Switch Rating (A)	Overall Dimensions			Switch Body				Switch Mounting		Connection	
	E min	E max	F	F1	F2	G	J	M	N	T	X
16 to 40	4.13 (105)	14.64 (372)	3.83 (97.5)	0.59 (15)	1.77 (45)	2.67 (68)	1.92 (48.75)	1.18 (30)	2.95 (75)	0.59 (15)	0.29 (7.5)
63 to 80	4.13 (105)	14.65 (372)	4.13 (105)	0.69 (17.5)	2.06 (52.5)	2.99 (76)	2.06 (52.5)	1.38 (35)	3.35 (85)	0.69 (17.5)	0.34 (8.75)

## External Selector and Pistol Handles

### Handle Type

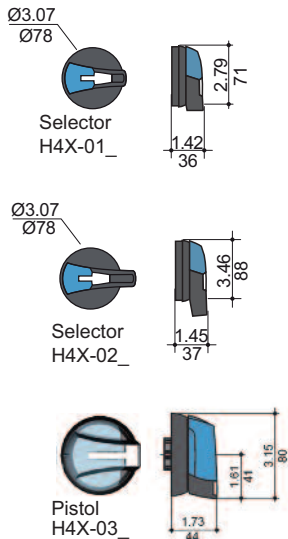

### Door Drilling Layouts

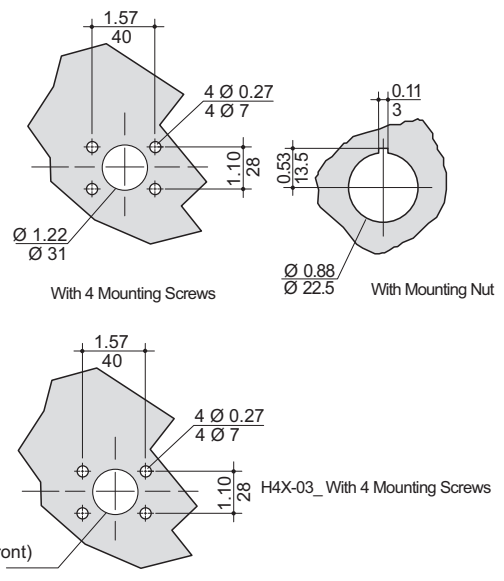

Ø 1.45in/37mm Screw clip (from front)  
Ø 1.22in/31mm Screw (from rear)

# UL 98 & UL 508 Enclosed Disconnect Switches

## Description

Fused and non-fused enclosed Rotary Disconnect Switches from 16 to 1200A in NEMA 1, 3R, 4, 4X, 12 enclosures.

## Features

- UL 98 Listed for general purpose, main disconnect, or branch circuit protection up to 600Vac/dc
- UL 508 Listed for motor disconnect applications up to 600Vac
- Multiple field installed accessories enhance the enclosed disconnect switches to fit the desired application
- Lockout/tagout: Up to three 1/4" shank padlocks can be installed on external handles

## Ratings:

- Volts: 600Vac  
250-600Vdc\*
- Amps: 16-1200A
- Short-Circuit Current Ratings: UL 98: 25kA-200kA  
UL 508: 10kA-65kA

\*Some non-fused disconnect switches are not rated for DC applications.

## Specifications

- Operating temperature: -20°C to 70°C
- 4X Plastic Enclosure Flammability Rating:  
Polycarbonate UL 94-5VA-0  
Fiberglass UL 94-5V

## Agency Information

- UL 98 Listed: File E182262, Guide WIAX, WIAX7
- UL 508 Listed: File E155129, Guide NLRV, NLRV7
- cULus Listed to CSA Standard 22.2, No. 14
- cULus Listed to CSA Standard 22.2, No. 4
- Conforms with IEC 60947-3
- CE Compliant
- RoHS Compliant

## Field Installed Accessories

- Auxiliary contacts
- Terminal shrouds
- Switched 4<sup>th</sup> pole (UL 508 only)

## Online Resources

Visit [www.cooperbussmann.com/Disconnects](http://www.cooperbussmann.com/Disconnects) for:

- CAD Drawings
- Instruction Sheets
- UL Information



NEMA 1, 3R, 4 & 12



NEMA 4X  
304 Stainless  
Steel



NEMA 4X  
Polycarbonate  
or Fiberglass



QuikShip Everyday Service ships the most common part numbers within 24 hours. Contact your Bussmann representative for details.

Available Bussmann Fuses		
Class	Type	Data Sheet #
CC	LP-CC Time-Delay, Current Limiting	1023
CC	FNQ-R Time-Delay	1014
CC	KTK-R Fast-Acting	1015
J	LPJ Time-Delay, Current Limiting	1006 (0-60A)
J		1007 (70-600A)
J	JKS Fast-Acting Fuses	1026 (0-60A)
J		1027 (70-600A)
J	DFJ High Speed Drive Fuse	1048 (0-600A)
L	KRP-C Time-Delay, Current Limiting	1008
L	KTU Fast-Acting	1010
L	KLU Time-Delay	1013

# UL 98 Enclosed Fused Disconnects—30 to 800A

## 3-Pole UL 98 600Vac

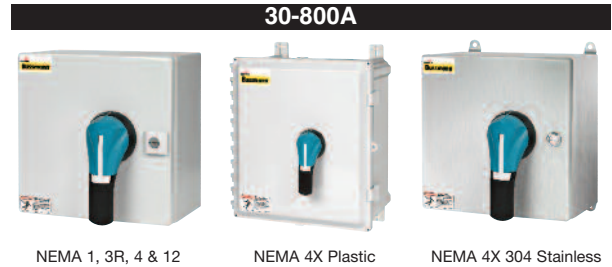
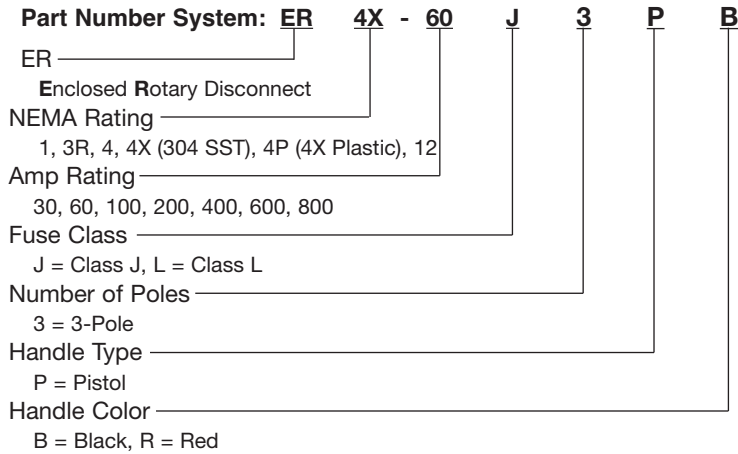

**Part Numbers** - All part numbers provided with integral or installed lugs and a black selector handle. Order red/yellow handle by changing the suffix “B” to “R.”

UL General Purpose Amp Rating	Fuse Type	NEMA Enclosure Type & Part Number					
		1	3R	4	4X Plastic <sup>(1)</sup>	4X 304 Stainless	12
30	J	ER1-30J3PB	ER3R-30J3PB	ER4-30J3PB	ER4P-30J3PB	ER4X-30J3PB	ER12-30J3PB
60	J	ER1-60J3PB	ER3R-60J3PB	ER4-60J3PB	ER4P-60J3PB	ER4X-60J3PB	ER12-60J3PB
100	J	ER1-100J3PB	ER3R-100J3PB	ER4-100J3PB	ER4P-100J3PB	ER4X-100J3PB	ER12-100J3PB
200	J	ER1-200J3PB	ER3R-200J3PB	ER4-200J3PB	ER4P-200J3PB	ER4X-200J3PB	ER12-200J3PB
400	J	ER1-400J3PB	ER3R-400J3PB	ER4-400J3PB	ER4P-400J3PB	ER4X-400J3PB	ER12-400J3PB
600	J	ER1-600J3PB	ER3R-600J3PB	ER4-600J3PB	ER4P-600J3PB	ER4X-600J3PB	ER12-600J3PB
800	L	ER1-800L3PB	ER3R-800L3PB	ER4-800L3PB	ER4P-800L3PB	ER4X-800L3PB	ER12-800L3PB

(1) Enclosures ≤100A are polycarbonate, flammability rating UL 94-5VA-V0, ≥200A are fiberglass, flammability rating UL 94-5V.

**Switch Ratings** - for wire types, ranges and tightening torques, see table on page 9

Switch Amp Rating	Disconnect Switch	Fuse Type	No. of Poles	Voltage		SCCR @ Vac	Max Hp Rating @ 600Vac
				Vac	Vdc		
30	RDF30J-3	J	3	600	250	200kA	20
60	RDF60J-3	J					50
100	RDF100J-3	J					75
200	RDF200J-3	J			N/A		150
400	RDF400J-3	J			250		350
600	RDF600J-3	J			600		500
800	RDF800L-3	L					



# UL 98 Enclosed Fused Disconnects—30 to 800A

## Enclosure Weights - Lbs & Dimensions - in

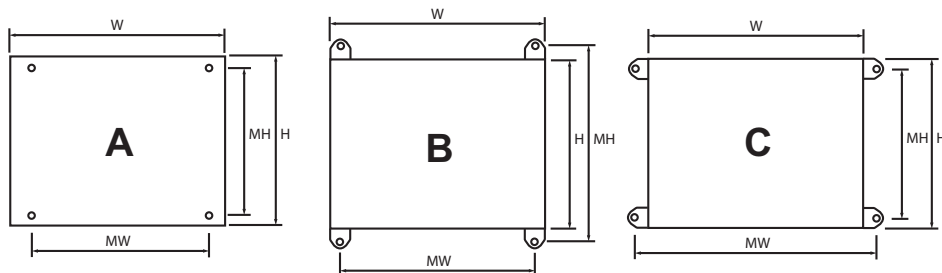

Part Number Family	Amp Rating	Fuse Type	NEMA Enclosure Type	H x W x D	Mounting Centers H x W			Weight Lbs
					A	B	C	
ER_-30J	30	J	1, 3R, 4, 12	10x10x6	8.3x8.3			15
			4X-304 SST	10x10x6		10.7x8.3	8.3x10.7	15
			4X-Plastic <sup>(1)</sup>	12x10x6		12x5.6	7.6x10	8
ER_-60J	60	J	1, 3R, 4, 12	12x10x6	10.3x8.3			19
			4X-304 SST	12x10x6		12.7x8.3	8.3x10.7	19
			4X-Plastic <sup>(1)</sup>	13x13x6		14x7.6	9.6x12	11
ER_-100J	100	J	1, 3R, 4, 12	14x12x6	12.3x10.3			21
			4X-304 SST	14x12x6		14.7x10.3	12.3x12.7	21
			4X-Plastic <sup>(1)</sup>	13x13x6		14x7.6	9.6x12	12
ER_-200J	200	J	1, 3R, 4, 12	24x20x8	22.3x18.3			55
			4X-304 SST	24x20x8		24.7x18.3	22.3x20.7	55
			4X-Plastic <sup>(1)</sup>	27x21x10		25.75x14		39
ER_-400J	400	J	1, 3R, 4, 12	48x36x12	46.3x34.3			188
			4X-304 SST	48x36x12		48.7x34.3	46.3x36.7	188
			4X-Plastic <sup>(1)</sup>	51x37x14		50x28.5		186
ER_-600J	600	J	1, 3R, 4, 12	48x36x12	46.3x34.3			216
			4X-304 SST	48x36x12		48.7x34.3	46.3x36.7	216
			4X-Plastic <sup>(1)</sup>	51x37x14		50x28.5		214
ER_-800L	800	L	1, 3R, 4, 12	48x36x12	46.3x34.3			216
			4X-304 SST	48x36x12		48.7x34.3	46.3x36.7	216
			4X-Plastic <sup>(1)</sup>	51x37x14		50x28.5		214

(1) Enclosures ≤100A are polycarbonate, flammability rating UL 94-5VA-V0, ≥200A are fiberglass, flammability rating UL 94-5V.

## Available Field-Installed Accessories - Order Separately

	Auxiliary Contacts - for 30 to 800 Amp Switches					
	Contact Type	Number of Contacts	Continuous Amp Rating	Voltage Rating	Max Number of Aux Contacts per Switch	Part Number
NO	1	10A	600Vac	30 to 200A: 4 400 to 800A: 8	BAC05	
NC	1	10A	600Vac		BAC06	

	Terminal Shrouds - for 200 to 800 Amp Switches - includes terminal shroud for lineside or loadside			Part Number
	Switch Amp Rating	Number of Poles		
200	3			TSH8-3TB
400	3			TSH9-3TB
600-800	3			TSH10-3TB

# UL 98 Enclosed Non-Fused Disconnects—30 to 1200A

## 3-Pole UL 98 600Vac

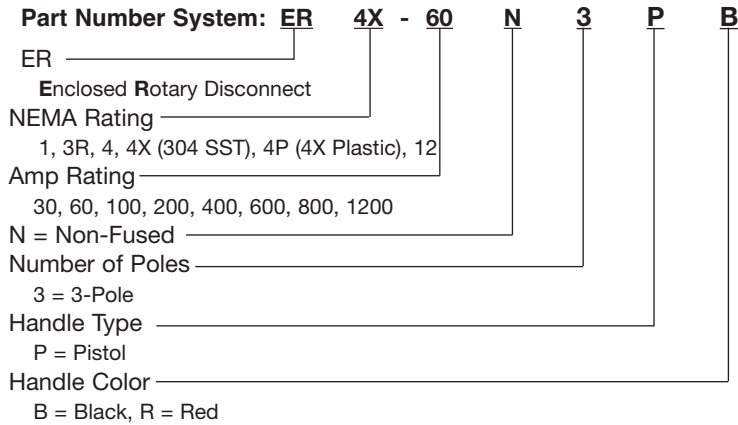

### 30-100A



NEMA 1, 3R, 4 & 12      NEMA 4X      NEMA 4X 304 Stainless

### 200-1200A



NEMA 1, 3R, 4 & 12      NEMA 4X      NEMA 4X 304 Stainless

**Part Numbers** - All part numbers provided with integral or installed lugs and a black selector handle. Order red/yellow handle by changing the suffix "B" to "R."

UL General Purpose Amp Rating	NEMA Enclosure Type & Part Number					
	1	3R	4	4X Plastic <sup>(1)</sup>	4X 304 Stainless	12
30	ER1-30N3PB	ER3R-30N3PB	ER4-30N3PB	ER4P-30N3PB	ER4X-30N3PB	ER12-30N3PB
60	ER1-60N3PB	ER3R-60N3PB	ER4-60N3PB	ER4P-60N3PB	ER4X-60N3PB	ER12-60N3PB
100	ER1-100N3PB	ER3R-100N3PB	ER4-100N3PB	ER4P-100N3PB	ER4X-100N3PB	ER12-100N3PB
200	ER1-200N3PB	ER3R-200N3PB	ER4-200N3PB	ER4P-200N3PB	ER4X-200N3PB	ER12-200N3PB
400	ER1-400N3PB	ER3R-400N3PB	ER4-400N3PB	ER4P-400N3PB	ER4X-400N3PB	ER12-400N3PB
600	ER1-600N3PB	ER3R-600N3PB	ER4-600N3PB	ER4P-600N3PB	ER4X-600N3PB	ER12-600N3PB
800	ER1-800N3PB	ER3R-800N3PB	ER4-800N3PB	ER4P-800N3PB	ER4X-800N3PB	ER12-800N3PB
1200	ER1-1200N3PB	ER3R-1200N3PB	ER4-1200N3PB	N/A	ER4X-1200N3PB	ER12-1200N3PB

(1) Enclosures ≤100A are polycarbonate, flammability rating UL 94-5VA-V0, ≥200A are fiberglass, flammability rating UL 94-5V.

**Switch Ratings** - for wire types, ranges and tightening torques, see table on page 27

Switch Amp Rating	Disconnect Switch	No. of Poles	Volts AC	SCCR	Max Hp Rating @ 600Vac
30	RD30-3	3	600	100kA	25
60	RD60-3				
100	RD100-3				
200	RD200-3			25kA/100kA*	200
400	RD400-3				
600	RD600-3			200kA	350
800	RD800-3				
1200	RD1200-3	100kA	500		

\* 25kA @ 600Vac, 100kA @ 480Vac.

# UL 98 Enclosed Non-Fused Disconnects—30 to 1200A

## Enclosure Weights - Lbs and Dimensions - in

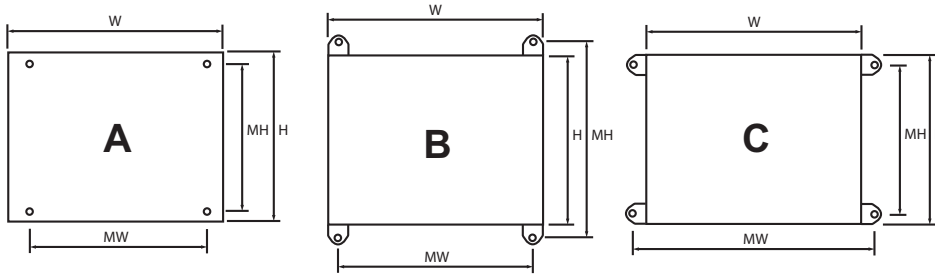

Part Number Family	Amp Rating	NEMA Enclosure Type	H x W x D	Mounting Centers H x W			Weight Lbs
				A	B	C	
ER_-30	30	1, 3R, 4, 12	10x8x6	8.3x6.3			11
		4X-304 SST	10x8x6		10.7x6.3	8.3x8.7	11
		4X-Plastic <sup>(1)</sup>	9x9x6		10x3.6	5.6x8	5
ER_-60	60	1, 3R, 4, 12	10x8x6	8.3x6.3			12
		4X-304 SST	10x8x6		10.7x6.3	8.3x8.7	12
		4X-Plastic <sup>(1)</sup>	9x9x6		10x3.6	5.6x8	5
ER_-100	100	1, 3R, 4, 12	12x10x6	10.3x8.3			12
		4X-304 SST	12x10x6		12.7x8.3	8.3x10.7	12
		4X-Plastic <sup>(1)</sup>	13x13x6		14x7.6	9.6x12	8
ER_-200	200	1, 3R, 4, 12	20x16x8	18.3x14.3			39
		4X-304 SST	20x16x8		20.7x14.3	18.3x16.7	39
		4X-Plastic <sup>(1)</sup>	20x17x12		21.5x10.1		31
ER_-400	400	1, 3R, 4, 12	36x30x8	34.3x28.3			122
		4X-304 SST	36x30x8		36.7x28.3	34.3x30.7	122
		4X-Plastic <sup>(1)</sup>	37x32x14		38x28.9		103
ER_-600	600	1, 3R, 4, 12	48x36x12	46.3x34.3			209
		4X-304 SST	48x36x12		48.7x34.3	46.3x36.7	209
		4X-Plastic <sup>(1)</sup>	51x37x 14		50x28.5		187
ER_-800	800	1, 3R, 4, 12	48x36x12	46.3x34.3			211
		4X-304 SST	48x36x12		48.7x34.3	46.3x36.7	211
		4X-Plastic <sup>(1)</sup>	51x37x 14		50x28.5		189
ER_-1200	1200	1, 3R, 4, 12	60x36x16	58.3x34.3			268
		4X-304 SST	60x36x16		60.7x34.3	58.3x36.7	268

(1) Enclosures ≤100A are polycarbonate, flammability rating UL 94-5VA-V0, ≥200A are fiberglass, flammability rating UL 94-5V.

## Available Field-Installed Accessories - Order Separately

Switch Amp Rating	Auxiliary Contacts - for 30 to 1200 Amp Switches						
	Contact Type	Number of Contacts	Continuous Amp Rating	Voltage Rating	Max Number of Aux Contacts per Switch	Part Number	
30-100	NO + NC	1 of each	10A	240Vac	4	BAC01*	
30-100	NO	2	10A	240Vac	4	BAC02*	
200-1200	NO + NC	1 of each	10.1A	125-250Vac	2	BAC03**	
200-1200	NO + NC	1 of each	10.1A	125-250Vac	2	BAC04**	
200-1200	NO + NC	1 of each	1A	125Vac	2	BAC11**	
200-1200	NO + NC	1 of each	1A	125Vac	2	BAC12**	

\* Two (2) units per switch max.  
\*\* For one auxiliary contact, install either BAC03 or BAC11. For two auxiliary contacts, install BAC03 + BAC04, or BAC11 + BAC12.

Switch Amp Rating	Terminal Shrouds - for 200 to 800 Amp Switches			
	Number of Poles	Location on Switch	Part Number	
30-100	3	Lineside and Loadside	TSH3-3TB	
200A	3	Lineside	TSH4-3T	
200A	3	Loadside	TSH4-3B	
400A	3	Lineside	TSH5-3T	
400A	3	Loadside	TSH5-3B	
600A	3	Lineside or Loadside	TSH6-3TB	
800-1200A	3	Lineside or Loadside	TSH7-3TB	

# UL 508 Enclosed Non-Fused Disconnects—16 to 80A

## 3-/6-Pole UL 508 600Vac

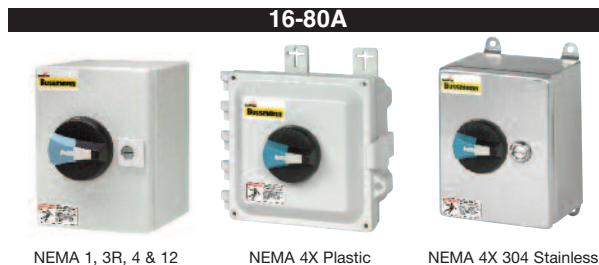
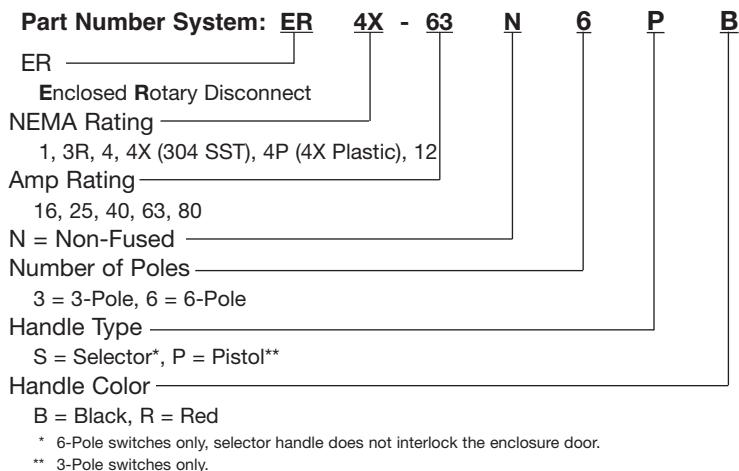

**Part Numbers** - All part numbers provided with a black selector handle. Order red/yellow handle by changing the suffix “B” to “R.”

UL General Purpose Amp Rating	No. of Poles	NEMA Enclosure Type & Part Number					
		1	3R	4	4X Plastic <sup>(1)</sup>	4X 304 Stainless	12
16	3	ER1-16N3PB	ER3R-16N3PB	ER4-16N3PB	ER4P-16N3PB	ER4X-16N3PB	ER12-16N3PB
	6	ER1-16N6SB	ER3R-16N6SB	ER4-16N6SB	ER4P-16N6SB	ER4X-16N6SB	ER12-16N6SB
25	3	ER1-25N3PB	ER3R-25N3PB	ER4-25N3PB	ER4P-25N3PB	ER4X-25N3PB	ER12-25N3PB
	6	ER1-25N6SB	ER3R-25N6SB	ER4-25N6SB	ER4P-25N6SB	ER4X-25N6SB	ER12-25N6SB
40	3	ER1-40N3PB	ER3R-40N3PB	ER4-40N3PB	ER4P-40N3PB	ER4X-40N3PB	ER12-40N3PB
	6	ER1-40N6SB	ER3R-40N6SB	ER4-40N6SB	ER4P-40N6SB	ER4X-40N6SB	ER12-40N6SB
63	3	ER1-63N3PB	ER3R-63N3PB	ER4-63N3PB	ER4P-63N3PB	ER4X-63N3PB	ER12-63N3PB
	6	ER1-63N6SB	ER3R-63N6SB	ER4-63N6SB	ER4P-63N6SB	ER4X-63N6SB	ER12-63N6SB
80	3	ER1-80N3PB	ER3R-80N3PB	ER4-80N3PB	ER4P-80N3PB	ER4X-80N3PB	ER12-80N3PB
	6	ER1-80N6SB	ER3R-80N6SB	ER4-80N6SB	ER4P-80N6SB	ER4X-80N6SB	ER12-80N6SB

(1) Polycarbonate enclosure flammability rating UL 94-5VA-V0.

**Switch Ratings** - for wire types, ranges and tightening torques, see table on page 35

Switch Amp Rating	Disconnect Switch	Voltage		SCCR with Max Upstream Class J Fuse	Max Hp Rating @ 600Vac
		Vac	Vdc		
16	RD16-3-508	600	N/A	65kA / 30A	10
25	RD25-3-508			65kA / 30A	20
40	RD40-3-508			65kA / 30A — 10kA / 60A	25
63	RD63-3-508			65kA / 60A — 50kA / 100A	40
80	RD80-3-508			65kA / 60A — 50kA / 100A	40

Note: Voltage, SCCR and Horsepower ratings are the same for 3- and 6-pole UL 508 non-fused disconnect switches.

# UL 508 Enclosed Non-Fused Disconnects— 16 to 80A

## Enclosure Weights - Lbs & Dimensions - in

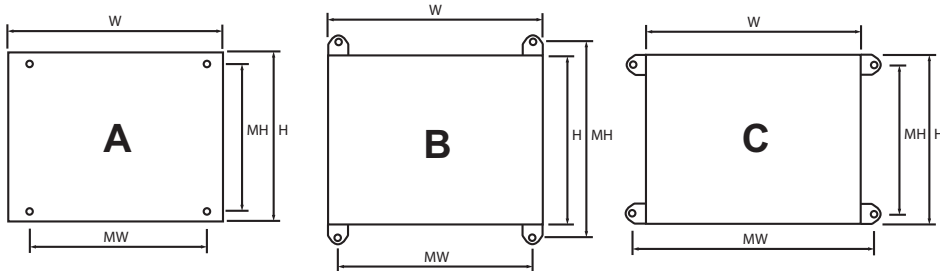

NEMA Enclosure Type	No. of Poles	Switch Amp Ratings	H x W x D	Mounting Centers H x W			Weight Lbs
				A	B	C	
1, 3R, 4, 12	3	16-80A	8x6x6	6.3x4.3			8
	6	16-80A	10x8x6	8.3x6.3			11
4X-304 SST	3	16-80A	8x6x6		8.7x4.3	6.3x6.7	8
	6	16-80A	10x8x6		10.7x6.3	8.3x8.7	11
4X-Plastic <sup>(1)</sup>	3	16-63A	7.4x8.7x5.8		8x3.6	3.6x8	4
		80A	9.4x8.7x5.9		10x3.6	5.6x8	5
	6	16-80A	11.4x10.7x6.3		12x5.6	7.6x10	6

(1) Polycarbonate.

## Available Field-Installed Accessories - Order Separately

	Auxiliary Contacts					
	Contact Type	Number of Contacts	Continuous Amp Rating	Voltage Rating	Max Number of Units per Switch	Part Number
	NO + NC	1 Ea	10A	240Vac	2 (1 per side/4 contacts total)	BAC01
NO	2	10A	240Vac	2 (1 per side/4 contacts total)	BAC02	

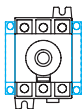

Auxiliary Contact Configurations

	Terminal Shrouds - includes terminal shroud for both lineside <i>and</i> loadside				
	Switch Amp Rating	Number of Poles		Location on Switch	Part Number
	16-40A	3		Lineside and Loadside	TSH1-3TB
63-80A	3		Lineside and Loadside	TSH2-3TB	

	Switched 4 <sup>th</sup> Pole - converts 3-pole switch to 4-pole switch	
	Switch Amp Rating	Part Number
	16	POLE-16
	25	POLE-25
40	POLE-40	

## Part Number Index

Part Number	Page #	Part Number	Page #	Part Number	Page #
BAC01	28, 35, 36, 43, 45	ER12-400N3PB	42	ER4-16N6PB	44
BAC02	28, 35, 36, 43, 45	ER12-40N3PB	44	ER4-200J3PB	40
BAC03	30, 32, 43	ER12-40N6PB	44	ER4-200N3PB	42
BAC04	30, 32, 43	ER1-25N3PB	44	ER4-25N3PB	44
BAC05	10, 13, 15, 17, 19, 21, 24, 41	ER1-25N6PB	44	ER4-25N6PB	44
BAC06	10, 13, 15, 17, 19, 21, 24, 41	ER12-600N3PB	42	ER4-30J3PB	40
BAC11	30, 32, 43	ER12-60J3PB	40	ER4-30N3PB	42
BAC12	30, 32, 43	ER12-60N3PB	42	ER4-400J3PB	40
BAC-HOLDER2	10	ER12-63N3PB	44	ER4-400N3PB	42
CCP-1-100CF	6	ER12-63N6PB	44	ER4-40N3PB	44
CCP-1-30CC	4	ER12-800L3PB	40	ER4-40N6PB	44
CCP-1-30CF	6	ER12-800N3PB	42	ER4-600J3PB	40
CCP-1-30DCC	4	ER12-80N3PB	44	ER4-600N3PB	42
CCP-1-30DCM	4	ER12-80N6PB	44	ER4-60J3PB	40
CCP-1-30M	4	ER1-30J3PB	40	ER4-60N3PB	42
CCP-1-60CF	6	ER1-30N3PB	42	ER4-63N3PB	44
CCP-2-100CF	6	ER1-400J3PB	40	ER4-63N6PB	44
CCP-2-30CC	4	ER1-400N3PB	42	ER4-800L3PB	40
CCP-2-30CF	6	ER1-40N3PB	44	ER4-800N3PB	42
CCP-2-30M	4	ER1-40N6PB	44	ER4-80N3PB	44
CCP-2-60CF	6	ER1-600J3PB	40	ER4-80N6PB	44
CCP-3-100CF	6	ER1-600N3PB	42	ER4P-100J3PB	40
CCP-3-30CC	4	ER1-60J3PB	40	ER4P-100N3PB	42
CCP-3-30CF	6	ER1-60N3PB	42	ER4P-16N3PB	44
CCP-3-30M	4	ER1-63N3PB	44	ER4P-16N6PB	44
CCP-3-60CF	6	ER1-63N6PB	44	ER4P-200J3PB	40
CCP-AUX	5, 7	ER1-800L3PB	40	ER4P-200N3PB	42
CCP-AUX-100	7	ER1-800N3PB	42	ER4P-25N3PB	44
CCPHM-FXX	5, 7	ER1-80N3PB	44	ER4P-25N6PB	44
CCPHM-RXX	7	ER1-80N6PB	44	ER4P-30J3PB	40
CCP-PLC-100	7	ER3R-100J3PB	40	ER4P-30N3PB	42
CCP-PLC-IND	5, 7	ER3R-100N3PB	42	ER4P-400J3PB	40
DIR-01	36	ER3R-1200N3PB	42	ER4P-400N3PB	42
DIR-02	28	ER3R-16N3PB	44	ER4P-40N3PB	44
DIR-03	30, 31	ER3R-16N6PB	44	ER4P-40N6PB	44
DIR-04	32, 33	ER3R-200J3PB	40	ER4P-600J3PB	40
DIR-05	10	ER3R-200N3PB	42	ER4P-600N3PB	42
DIR-06	10	ER3R-25N3PB	44	ER4P-60J3PB	40
DIR-07	12, 14, 16, 18, 20	ER3R-25N6PB	44	ER4P-60N3PB	42
DIR-08	24, 25	ER3R-30J3PB	40	ER4P-63N3PB	44
DOOR-508	36	ER3R-30N3PB	42	ER4P-63N6PB	44
ER1-100J3PB	40	ER3R-400J3PB	40	ER4P-800L3PB	40
ER1-100N3PB	42	ER3R-400N3PB	42	ER4P-800N3PB	42
ER1-1200N3PB	42	ER3R-40N3PB	44	ER4P-80N3PB	44
ER1-16N3PB	44	ER3R-40N6PB	44	ER4P-80N6PB	44
ER1-16N6PB	44	ER3R-600J3PB	40	ER4X-100J3PB	40
ER1-200J3PB	40	ER3R-600N3PB	42	ER4X-100N3PB	42
ER1-200N3PB	42	ER3R-60J3PB	40	ER4X-1200N3PB	42
ER12-100N3PB	42	ER3R-60N3PB	42	ER4X-16N3PB	44
ER12-1200N3PB	42	ER3R-63N3PB	44	ER4X-16N6PB	44
ER12-16N3PB	44	ER3R-63N6PB	44	ER4X-200J3PB	40
ER12-16N6PB	44	ER3R-800L3PB	40	ER4X-200N3PB	42
ER12-200J3PB	40	ER3R-800N3PB	42	ER4X-25N3PB	44
ER12-200N3PB	42	ER3R-80N3PB	44	ER4X-25N6PB	44
ER12-25N3PB	44	ER3R-80N6PB	44	ER4X-30J3PB	40
ER12-25N6PB	44	ER4-100J3PB	40	ER4X-30N3PB	42
ER12-30J3PB	40	ER4-100N3PB	42	ER4X-400J3PB	40
ER12-30N3PB	42	ER4-1200N3PB	42	ER4X-400N3PB	42
ER12-400J3PB	40	ER4-16N3PB	44	ER4X-40N3PB	44

## Part Number Index

Part Number	Page #	Part Number	Page #	Part Number	Page #
ER4X-40N6PB	44	H4X-08RHD	32	RDF400J-2	20
ER4X-600J3PB	40	H79-2	12, 14, 17, 19, 21	RDF400J-3	20, 21, 40
ER4X-600N3PB	42	H79-3	21	RDF400J-4	20
ER4X-60J3PB	40	H79-4	24	RDF600J-2	24
ER4X-60N3PB	42	KIT-6POLE	37	RDF600J-3	24, 25, 40
ER4X-63N3PB	44	LUG1-2	20, 30	RDF600J-4	24
ER4X-63N6PB	44	LUG1-3	20, 30	RDF60J-2	16
ER4X-800L3PB	40	LUG1-4	20, 30	RDF60J-3	16, 40
ER4X-800N3PB	42	LUG2-2	20, 30	RDF60J-4	16
ER4X-80N3PB	44	LUG2-3	20, 30	RDF800L-2	24
ER4X-80N6PB	44	LUG2-4	20, 30	RDF800L-3	24, 25, 40
FLC120	12, 14, 16, 18, 21	LUG3-2	30	RDF800L-4	24
FLC36	12, 14, 16, 18, 21	LUG3-3	30	SH1-200	10
FLC60	12, 14, 16, 18, 21	LUG3-4	30	SH1-320	10
FLCM	12, 14, 16, 18, 21	LUG5-2	24	SH1-400	10
FLH1	12, 14, 16, 18, 21	LUG5-3	24, 32	SH2-200	10
FLH2	12, 14, 16, 18, 21	LUG5-4	24, 32	SH2-320	10
FLRM	12, 14, 16, 18, 21	LUG6-6	32	SH2-400	10
GND-16-40	35, 37	LUG6-8	32	SH3-200	28, 36
GND-63-80	35, 37	POLE-16	37, 45	SH3-320	28, 36
NTRL-16-40	35, 37	POLE-25	37, 45	SH3-400	28, 36
NTRL-60-80	35, 37	POLE-40	37, 45	SH4-150	28, 35, 36
H12-03B	16, 18, 20, 30	POLE98-100	28	SH4-200	28, 35, 36
H12-03R	16, 18, 20, 30	POLE98-30	28	SH4-320	28, 35, 36
H12-05B	10, 12, 14	POLE98-60	28	SH5-200	12, 14, 16, 18, 20, 30
H12-05R	10, 12, 14	RD1000-3	32	SH5-320	12, 14, 16, 18, 20, 30
H4X-01B	28, 35, 36	RD1000-4	32	SH5-400	12, 14, 16, 18, 20, 30
H4X-01R	28, 35, 36	RD100-3	28, 42	SH6-200	32
H4X-02B	28, 35, 36	RD100-3-SCCR	30	SH6-320	32
H4X-02R	28, 35, 36	RD1200-3	28, 42	SH6-400	32
H4X-03B	28, 36	RD1200-4	32	SH7-200	24
H4X-03BHD	28, 36	RD16-3-508	36, 44	SH7-320	24
H4X-03R	28, 36	RD200-3	30, 42	SH7-400	24
H4X-03RHD	28, 36	RD200-4	30	SH-GUIDE1	28, 35, 36
H4X-04B	10	RD25-3-508	36, 44	SH-GUIDE2	28, 30, 32, 36
H4X-04R	10	RD30-3	28, 42	TSH10-2TB	24
H4X-05B	10, 12, 14	RD400-3	30, 42	TSH10-3TB	24, 41
H4X-05BHD	10, 12, 14	RD400-4	30	TSH10-4TB	24
H4X-05R	10, 12, 14	RD400-3-508	36, 44	TSH1-1TB	37
H4X-05RHD	10, 12, 14	RD600-3	32, 42	TSH1-3TB	37, 45
H4X-05PB	12, 14	RD600-4	32	TSH2-3TB	37, 45
H4X-05SR	12, 14	RD60-3	28, 42	TSH3-1TB	28
H4X-05TB	10, 12, 14	RD63-3-508	36, 4	TSH3-3TB	28, 43
H4X-05TR	10, 12, 14	RD800-3	32, 42	TSH4-3B	31, 43
H4X-06B	16, 18, 20, 30	RD800-4	32	TSH4-3T	31, 43
H4X-06BHD	16, 18, 20, 30	RD80-3-508	36, 44	TSH4-4TB	31
H4X-06R	16, 18, 20, 30	RDF100J-2	18	TSH5-3B	31, 43
H4X-06RHD	16, 18, 20, 30	RDF100J-3	18, 40	TSH5-3T	31, 43
H4X-06PB	16, 18, 20	RDF100J-4	18	TSH5-4TB	31
H4X-06SR	16, 18, 20	RDF200J-2	20	TSH6-3TB	33, 43
H4X-06TB	16, 18, 20	RDF200J-3	20, 21, 40	TSH6-4TB	33
H4X-06TR	16, 18, 20	RDF200J-4	20	TSH7-3TB	33, 43
H4X-07B	24, 32	RDF30CC-3	10	TSH7-4TB	33
H4X-07BHD	24, 32	RDF30CC-3N	10	TSH8-2TB	21
H4X-07R	24, 32	RDF30J-2	12	TSH8-3TB	21, 41
H4X-07RHD	24, 32	RDF30J-3	12, 40	TSH8-4TB	21
H4X-08B	32	RDF30J-3-COMP	10	TSH9-2TB	21
H4X-08BHD	32	RDF30J-3N-COMP	10	TSH9-3TB	21, 41
H4X-08R	32	RDF30J-4	12	TSH9-4TB	21

# Customer Assistance

## Customer Satisfaction Team

Available to answer questions regarding Bussmann series products and services Monday-Friday, 8:00 a.m. – 6:00 p.m. Central Time. Contact:

- Toll-free phone: 855-287-7626 (855-BUSSMANN)
- Toll-free fax: 800-544-2570
- E-mail: [busscustsat@Eaton.com](mailto:busscustsat@Eaton.com)

## Emergency and After-Hours Orders

Next flight out or will call shipment for time-critical needs. Customers pay only standard product price, rush freight charges and a modest emergency service fee. Place these orders through the Customer Satisfaction Team during regular business hours. For after-hours, contact:

- After hours 314-995-1342

## C3 – the Enhanced, Online Cooper Customer Center

Provides real time product availability, net pricing, order status and shipment tracking for: B-Line, Bussmann, Crouse-Hinds, Lighting, Power Systems & Wiring Devices. Call 877-995-5955 for log-in assistance. Available at:

- [www.cooperc3.com](http://www.cooperc3.com)

## Application Engineering

Technical assistance is available to all customers. Application support is available Monday-Friday, 7:00 a.m. – 5:00 p.m. Central Time. Contact:

- Toll-free phone: 855 287-7626 (855-BUSSMANN)
- E-mail: [fusetech@Eaton.com](mailto:fusetech@Eaton.com)

## Online Resources

Visit [www.cooperbussmann.com](http://www.cooperbussmann.com) for the following resources:

- Product search and cross-reference
- Product and technical materials
- Solutions centers for information on topical issues including arc flash, selective coordination & short-circuit current rating
- Technical tools, like our arc flash calculator
- Where to purchase Bussmann series product

**Eaton's Bussmann Business**  
PO Box 14460  
St. Louis, MO 63178-44602

## Your Authorized Distributor is:



**Eaton**  
1000 Eaton Boulevard  
Cleveland, OH 44122  
[Eaton.com](http://Eaton.com)

Bussmann Division  
114 Old State Road  
Ellisville, MO 63021  
United States  
[Eaton.com/bussmannseries](http://Eaton.com/bussmannseries)

© 2016 Eaton  
All Rights Reserved  
Printed in USA  
Publication No. 10076  
June 2016

Eaton is a registered trademark

All other trademarks are property of their respective owners.



Powering Business Worldwide